

專業製造切削工具
PROFESSIONAL CUTTING TOOLS

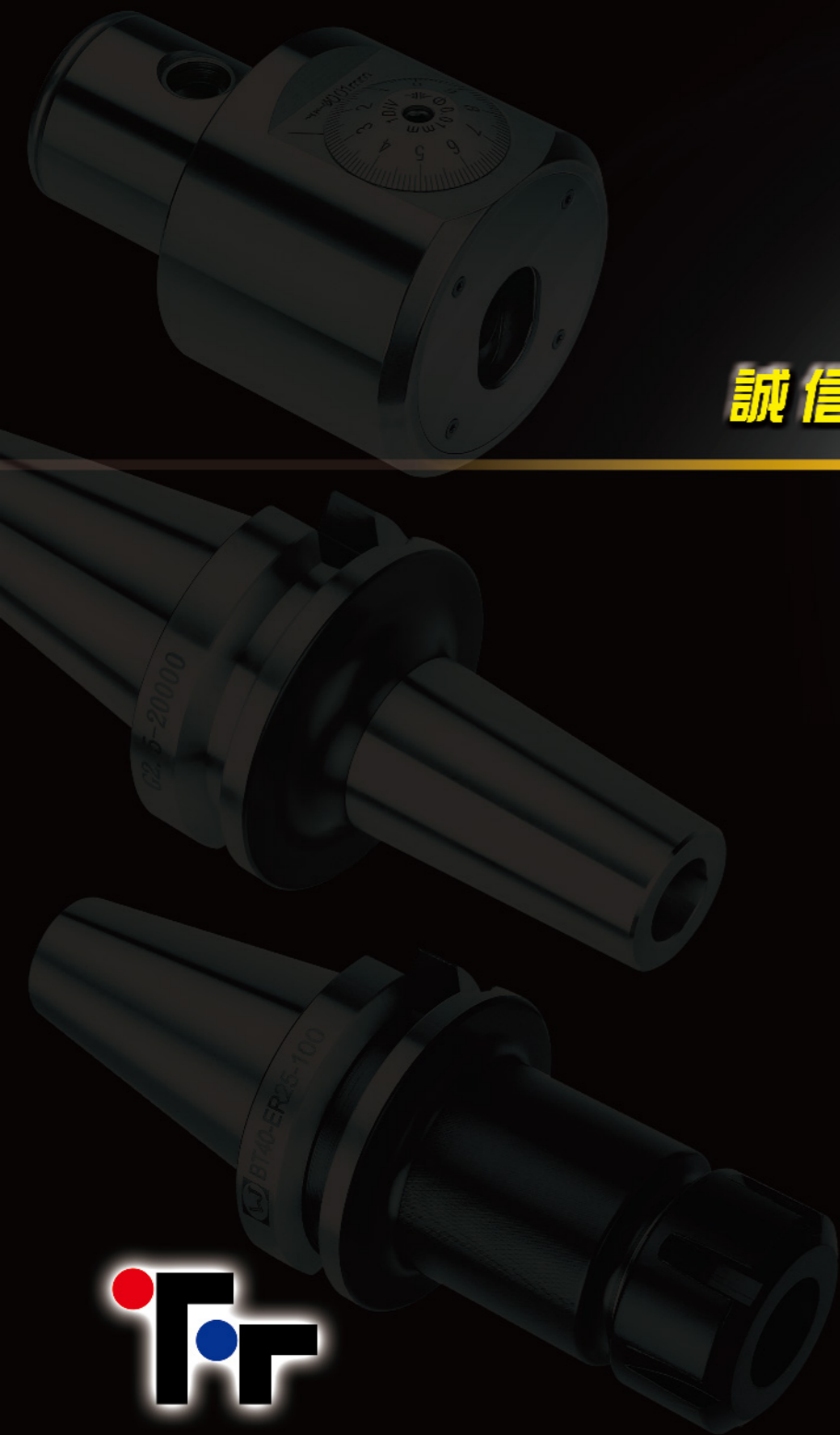

誠信 · 專業 · 創新



台灣總公司

台中市豐原區仁洲街64號 電話：+886-4-25293265 傳真：+886-4-25299933

大中華地區

■ **昆山公司**

昆山市新南路567號恆龍機電城A棟1905
電話：0512-57561026
傳真：0512-57560426

■ **東莞公司**

東莞市虎門鎮北柵工業區南坊大社路25號3樓
電話：0769-89119518
傳真：0769-89221518

<http://www.toptap.com.tw>

E-mail: market@toptap.com.tw

2013.05

塔普特精密刀具股份有限公司
TOPTAP PRECISION TOOLS CO., LTD.

www.toptap.com.tw



At Present, four types of solid carbide material are being utilized for TOPTAP's end mills. According to the characteristics and the tests that we've done, each material is well selected and respectively applied to various applications to achieve its best solutions ! The material is from Germany and Japan.

Type of Solid Carbide Material	WC %	Co %	Average Grain Size μm	GPA T.R.S. N/mm ²	Desity ISO 3369 [g/cm ³]	Hardness Vickers HV30	Coating		Working Material's Hardness
A	90	10	0.6	3600	14.5	1610	Futura Nano	TiAlN	HRC 50
B	86.65	13	0.4	3900	13.9	1700	X.CEED	XCEED	HRC 58
C	89.8	9	0.2	4000	14.3	2000	ALDURA	ALDURA	HRC 68

Hardness

Work material hardness is up to HRC50, HRC55, HRC58, HRC60, HRC62, HRC65, HRC68.

Flute

S Type

It is suitable for three-dimensional curved surface cutting.

Helix Angle

Helix is 15°, 30°, 35°, 45°, 55°.

Corner R

Flute Edge

	SED	極細微粒碳化鎢 微小徑 2刃立銑刀 Micro Grain Carbide, Micro Diameter Miniature, 2- flute, End Mills	P1
	HSE	極細微粒碳化鎢 長頸短刃 2刃立銑刀 Micro Grain Carbide, Long Neck, Short Flute, 2 - flute, End Mills	P2
	SED	極細微粒碳化鎢 4刃立銑刀 (高速高硬度專用刀) Micro Grain Carbide, 4- flute, End Mills (Sword for High-speed and High-hardness)	P3
	SED	極細微粒碳化鎢 2刃立銑刀 Micro Grain Carbide, 2- flute, End Mills	P4-6
	SED	極細微粒碳化鎢 4刃立銑刀 Micro Grain Carbide, 4-flute, End Mills	P7-8
	SED	極細微粒碳化鎢 4刃立銑刀(不鏽鋼專用) Micro Grain Carbide, 4-flute, End Mills (for Stainless Steel Processing)	P9
	SED	極細微粒碳化鎢 長刃型 2刃立銑刀 Micro Grain Carbide, Long-flute, 2-flute, End Mills	P10-11
	SED	極細微粒碳化鎢 長刃型 4刃立銑刀 (35度) Micro Grain Carbide, Long-flute, 4-flute, End Mills(Helix Angle 35)	P12-13
	SED	極細微粒碳化鎢 長刃型 4刃立銑刀 (45度) Micro Grain Carbide, Long-flute, 4-flute, End Mills(Helix Angle 45)	P14-15
	SEDH	重切削 4刃立銑刀 Heavy Cutting, 4-flute, End Mills	<i>New</i> P16-17
	SED	極細微粒碳化鎢 6刃立銑刀 Micro Grain Carbide, 6- flute, End Mills	P18
	LSED	極細微粒碳化鎢 長刃型 6刃立銑刀 Micro Grain Carbide, Long-flute, 6- flute, End Mills	P19
	SED	極細微粒碳化鎢 3刃立銑刀(鈦合金專用) Micro Grain Carbide, 3- flute, End Mills(for Titanium Alloys Processing)	<i>New</i> P20
	FRE	極細微粒碳化鎢 4刃粗銑立銑刀 Micro Grain Carbide, 4- flute, Roughing, End Mills	P21
	MR	極細微粒碳化鎢 2刃球型立銑刀 (高速高硬度專用刀) Micro Grain Carbide, 2 - flute, Ball End Mills (Sword for High-speed and High-hardness)	P22
	MR	極細微粒碳化鎢 微小徑 2刃球型立銑刀 Micro Grain Carbide, Micro Diameter Miniature, 2 - flute, Ball End Mills	P23
	HMR	極細微粒碳化鎢 長頸短刃 2刃球型立銑刀 Micro Grain Carbide, Long-neck, Short- flute, 2-flute, Ball End Mills	P24
	MR	極細微粒碳化鎢 2刃球型立銑刀 Micro Grain Carbide, 2- flute, Ball End Mills	P25-26

	LR	極細微粒碳化鎢 長柄 2刃球型立銑刀 Micro Grain Carbide, Long-shank, 2- flute, Ball End Mills	P27-28
	MR4	極細微粒碳化鎢 4刃球型立銑刀 Micro Grain Carbide, 4-flute, Ball End Mills	P29-30
	MBN	極細微粒碳化鎢 長斜頸 2刃球型立銑刀 Micro Grain Carbide, Long Taper-neck, 2-flute, Ball End Mills	P31-32
	HRM	極細微粒碳化鎢 長頸圓鼻 2刃立銑刀 Micro Grain Carbide, Long-neck, Corner-radius, 2-flute, End Mills	P33-34
	SEHR	重切削圓鼻 4刃立銑刀 Heavy Cutting, Corner-radius, 4-flute, End Mills	<i>New</i> P35-36
	HSER	極細微粒碳化鎢 長頸短刃圓鼻 2刃立銑刀 Micro Grain Carbide, Long-neck, Short-flute, Corner-radius, 2-flute, End Mills	P37-38
	2RM	極細微粒碳化鎢 圓鼻 2刃立銑刀 Micro Grain Carbide, Corner-radius, 2-flute, End Mills	P39-40
	4RM	極細微粒碳化鎢 圓鼻 4刃立銑刀 Micro Grain Carbide, Corner-radius, 4-flute, End Mills	P41-42
	2LRM	極細微粒碳化鎢 長柄圓鼻 2刃立銑刀 Micro Grain Carbide, Long-shank, Corner-radius, 2-flute, End Mills	P43-44
	4LRM	極細微粒碳化鎢 長柄圓鼻 4刃立銑刀 Micro Grain Carbide, Long-shank, Corner-radius, 4-flute, End Mills	P45-46
	H60RW	極細微粒碳化鎢 圓鼻 6刃立銑刀 Micro Grain Carbide, Corner-radius, 6-flute, End Mills	P47-48
	UR	極細微粒碳化鎢 2刃球型立銑刀(鋁合金專用) Micro Grain Carbide, 2- flute, Ball End Mills (for Aluminum Alloys Processing)	P49
	155WW	極細微粒碳化鎢 2刃立銑刀(鋁合金專用) Micro Grain Carbide, 2- flute, End Mills (for Aluminum Alloys Processing)	P50
	155WW	極細微粒碳化鎢 3刃立銑刀(鋁合金專用) Micro Grain Carbide, 3- flute, End Mills (for Aluminum Alloys Processing)	P50
	L155WW	極細微粒碳化鎢 長刃 2刃立銑刀(鋁合金專用) Micro Grain Carbide, Long-flute, 2- flute, End Mills (for Aluminum Alloys Processing)	P51
	L155WW	極細微粒碳化鎢 長刃 3刃立銑刀(鋁合金專用) Micro Grain Carbide, Long-flute, 3- flute, End Mills (for Aluminum Alloys Processing)	P51
	145WW	極細微粒碳化鎢 2刃 鏡面立銑刀(鋁合金專用) Micro Grain Carbide, 2- flute, Smooth Surface End Mills (for Aluminum Alloys Processing)	<i>New</i> P52
	145WW	極細微粒碳化鎢 3刃 鏡面立銑刀(鋁合金專用) Micro Grain Carbide, 3- flute, Smooth Surface End Mills (for Aluminum Alloys Processing)	<i>New</i> P52

	TPM	極細微粒碳化鎢 斜度刀 2刃立銑刀 Micro Grain Carbide, Taper, 2- flute, End Mills	P53-54
	TPM	極細微粒碳化鎢 斜度刀 4刃立銑刀 Micro Grain Carbide, Taper, 4- flute, End Mills	P55
	LSED	極細微粒碳化鎢 60°, 90°, 120° 2刃定位鑽頭 Micro Grain Carbide, NC Spot Drills 60°, 90°, 120° Degree	P56
	WJM	鋼用全鎢鑽頭 Solid Carbide Drills For Steel	P57-58
	WJM	全鎢鋼絞刀 Solid Carbide Reamers (Straight Shank)	P59-60
	HSER	鑽銑刀 High Speed Drills	P61-63
		立銑刀夾頭 (強力型刀頭) Power Grip Milling Chuck/KCH	P64
		BT30, BT40, BT50 一體式鑽夾頭 Drill Chuck Holder	P65
		ER銑刀夾頭 Coller Chuck/ER	P66
		NBJ16 精磨刀桿 Minor Diameter Bore	P67
		NBH2084 精磨刀桿 Minor Diameter Bore	P68
		SSD 高速精密筒夾刀桿 & SSD 4°高速精密筒夾 SSD Plus Chuck & SSD 4° Collet	<i>New</i> P69
		SDC 小徑後拉高速刀桿 & SDC 高速後拉筒夾 SDC Slim Chuck & SDC Collet (for end mill)	<i>New</i> P70
		KCH銑刀夾頭 Power Grip Milling Chuck / KCH	P71
		ER筒夾 ER Spring Collets	P72
		側固式立銑刀架 Side Mill Arbor	P73
		斜柄鑽頭套筒 Morse Taper Adaptor	P74
		刀盤使用刀杆 Face Mill Holder	P75
		SC筒夾 & 扳手 SC Spring Collets & Wrench	P75
		延長杆系列 Straight Shank	P76
		螺母與扳手系列 Clamping Nuts & Wrench Series	P77
		BT螺栓拉頭 & 刀庫主軸清潔棒(可替換式片) & 立橫兩用BT刀軸鎖刀座 BT Pull Stud & Spindle Taper Wipers & BT Tool Holder Locking Device	P78
		切削數據表 Recommend Cutting Conditions	P79-82

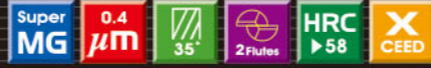

Micro Diameter

Type No. 型號	Diameter 刃徑 d1	Flute Length 刃長 l1	O. A. L. 全長 l3	Shank Dia. 柄徑 d2
SED001	0.1	0.2	50	4
SED002	0.2	0.4	50	4
SED003	0.3	0.6	50	4
SED004	0.4	0.8	50	4
SED005	0.5	1.0	50	4
SED006	0.6	1.2	50	4
SED007	0.7	1.4	50	4
SED008	0.8	1.6	50	4
SED009	0.9	1.8	50	4
SED010	1.0	2.5	50	4
SED012	1.2	3.0	50	4
SED015	1.5	4.0	50	4
SED016	1.6	4.0	50	4
SED018	1.8	5.0	50	4
SED020	2.0	6.0	50	4

High Speed Cutting
& High Hard Cutting

d1 (mm)	d1(mm) tolerance
0.1	0 -0.015
0.2	0 -0.015
0.3	0 -0.015
0.4	0 -0.015
0.5	0 -0.02
0.6	0 -0.02
0.7	0 -0.02
0.8	0 -0.02
1.0	0 -0.02
1.2	0 -0.02
1.5	0 -0.02
1.6	0 -0.02
1.8	0 -0.02
2.0	0 -0.02
2.5	0 -0.02
3.0	0 -0.02
4.0	0 -0.02

Shank(mm) (h6)	d2(mm) tolerance
Ø 4	0 -0.008

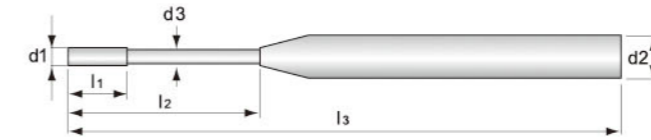

Micro Diameter

Type No. 型號	Diameter 刃徑 d1	Neck Dia d3	Flute Length 刃長 l1	Effective Length 有效長 l2	O. A. L. 全長 l3	Shank Dia. 柄徑 d2
HSE0502	0.5	0.46	0.8	2	50	4
HSE0504	0.5	0.46	0.8	4	50	4
HSE0506	0.5	0.46	0.8	6	50	4
HSE1006	1.0	0.95	1.5	6	50	4
HSE1008	1.0	0.95	1.5	8	50	4
HSE1010	1.0	0.95	1.5	10	50	4
HSE1012	1.0	0.95	1.5	12	50	4
HSE1508	1.5	1.44	2.0	8	50	4
HSE1510	1.5	1.44	2.0	10	50	4
HSE1512	1.5	1.44	2.0	12	50	4
HSE1516	1.5	1.44	2.0	16	50	4
HSE2008	2.0	1.92	3.0	8	50	4
HSE2010	2.0	1.92	3.0	10	50	4
HSE2012	2.0	1.92	3.0	12	50	4
HSE2016	2.0	1.92	3.0	16	50	4
HSE2020	2.0	1.92	3.0	20	50	4
HSE2510	2.5	2.40	3.0	10	50	4
HSE2512	2.5	2.40	3.0	12	50	4
HSE2516	2.5	2.40	3.0	16	50	4
HSE2520	2.5	2.40	3.0	20	50	4
HSE3010	3.0	2.90	4.0	10	50	6
HSE3012	3.0	2.90	4.0	12	50	6
HSE3016	3.0	2.90	4.0	16	50	6
HSE3020	3.0	2.90	4.0	20	60	6
HSE3025	3.0	2.90	4.0	25	60	6
HSE4012	4.0	3.90	5.0	12	75	6
HSE4014	4.0	3.90	5.0	14	75	6
HSE4016	4.0	3.90	5.0	16	75	6
HSE4020	4.0	3.90	5.0	20	75	6
HSE4025	4.0	3.90	5.0	25	75	6



High Speed Cutting
& High Hard Cutting

d1 (mm)	d1(mm) tolerance
0.5	0 -0.02
1.0	0 -0.02
1.5	0 -0.02
2.0	0 -0.02
2.5	0 -0.02
3.0	0 -0.02
4.0	0 -0.02

Shank(mm) (h6)	d2(mm) tolerance
Ø 4	0 -0.008
Ø 6	0 -0.008



High Speed Cutting
& High Hard Cutting

d1 (mm)	d1 (mm) tolerance
1.0	⁰ _{-0.005} ⁰ _{-0.02}
1.5	⁰ _{-0.005} ⁰ _{-0.02}
2.0	⁰ _{-0.005} ⁰ _{-0.02}
3.0	⁰ _{-0.02}
4.0	⁰ _{-0.02}
5.0	⁰ _{-0.02}
6.0	⁰ _{-0.025}
8.0	⁰ _{-0.025}
10.0	⁰ _{-0.03}
12.0	⁰ _{-0.035}
14.0	⁰ _{-0.04}
16.0	⁰ _{-0.04}
18.0	⁰ _{-0.05}
20.0	⁰ _{-0.05}
25.0	⁰ _{-0.05}

Shank(mm) (h6)	d2(mm) tolerance
Ø 3	⁰ _{-0.008}
Ø 4	⁰ _{-0.008}
Ø 6	⁰ _{-0.008}
Ø 8	⁰ _{-0.008}
Ø 10	⁰ _{-0.009}
Ø 12	⁰ _{-0.011}
Ø 14	⁰ _{-0.011}
Ø 16	⁰ _{-0.011}
Ø 18	⁰ _{-0.013}
Ø 20	⁰ _{-0.013}
Ø 25	⁰ _{-0.013}

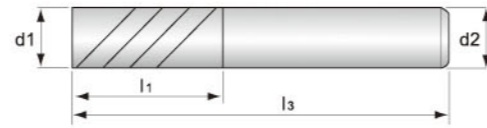

Micro Diameter

Type No. 型號	Diameter 刃徑 d1	Flute Length 刃長 l1	O. A. L. 全長 l3	Shank Dia. 柄徑 d2
SED354010FG	1.0	2.5	50	4
SED354015FG	1.5	4	50	4
SED354020FG	2.0	5	50	4
SED354025FG	2.5	7	50	4
SED354030FG	3.0	8	50	4
SED354040FG	4.0	10	50	4
SED354050G	5.0	13	50	6
SED354060G	6.0	15	50	6
SED354080G	8.0	20	60	8
SED354100G	10.0	25	75	10
SED354120G	12.0	30	75	12
SED354140G	14.0	35	80	14
SED354160G	16.0	40	100	16
SED354180G	18.0	40	100	18
SED354200G	20.0	45	100	20
SED354250G	25.0	45	100	25

Type No. 型號	Diameter 刃徑 d1	Flute Length 刃長 l1	O. A. L. 全長 l3	Shank Dia. 柄徑 d2
SED354010-3G	1.0	2.5	50	3
SED354015-3G	1.5	4	50	3
SED354020-3G	2.0	5	50	3
SED354025-3G	2.5	7	50	3
SED354030-3G	3.0	8	50	3
SED354-010G	1.0	2.5	50	6
SED354-015G	1.5	4	50	6
SED354-020G	2.0	5	50	6
SED354-025G	2.5	7	50	6
SED354-030G	3.0	8	50	6
SED354-040G	4.0	10	50	6

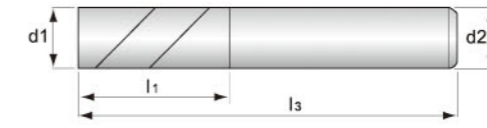

Micro Diameter

Type No. 型號	Diameter 刃徑 d1	Flute Length 刃長 l1	O. A. L. 全長 l3	Shank Dia. 柄徑 d2
352AL010F	1.0	2.5	50	4
352AL015F	1.5	4	50	4
352AL020F	2.0	5	50	4
352AL025F	2.5	7	50	4
352AL030F	3.0	8	50	4
352AL035F	3.5	10	50	4
352AL040F	4.0	10	50	4
352AL045	4.5	13	50	6
352AL050	5.0	13	50	6
352AL055	5.5	13	50	6
352AL060	6.0	15	50	6
352AL065	6.5	15	60	8
352AL070	7.0	17	60	8
352AL075	7.5	17	60	8
352AL080	8.0	20	60	8
352AL085	8.5	25	75	10
352AL090	9.0	25	75	10
352AL095	9.5	25	75	10
352AL100	10.0	25	75	10
352AL105	10.5	25	75	12
352AL110	11.0	28	75	12
352AL115	11.5	28	75	12
352AL120	12.0	30	75	12
352AL130	13.0	33	100	16
352AL140	14.0	35	100	16
352AL150	15.0	38	100	16
352AL160	16.0	40	100	16
352AL170	17.0	40	100	18
352AL180	18.0	40	100	18
352AL190	19.0	45	100	20
352AL200	20.0	45	100	20
352AL250	25.0	45	100	25

Type No. 型號	Diameter 刃徑 d1	Flute Length 刃長 l1	O. A. L. 全長 l3	Shank Dia. 柄徑 d2
352AL010-3	1.0	2.5	50	3
352AL015-3	1.5	4	50	3
352AL020-3	2.0	5	50	3
352AL030-3	3.0	8	50	3
352AL-010	1.0	2.5	50	6
352AL-015	1.5	4	50	6
352AL-020	2.0	5	50	6
352AL-025	2.5	7	50	6
352AL-030	3.0	8	50	6
352AL-035	3.5	10	50	6
352AL-040	4.0	10	50	6



High Speed Cutting
& High Hard Cutting

d1 (mm)	d1 (mm) tolerance
1.0	⁰ _{-0.005} ⁰ _{-0.02}
1.5	⁰ _{-0.005} ⁰ _{-0.02}
2.0	⁰ _{-0.005} ⁰ _{-0.02}
3.0	⁰ _{-0.005} ⁰ _{-0.02}
4.0	⁰ _{-0.005} ⁰ _{-0.02}
5.0	⁰ _{-0.005} ⁰ _{-0.02}
6.0	⁰ _{-0.01} ⁰ _{-0.025}
8.0	⁰ _{-0.01} ⁰ _{-0.025}
10.0	⁰ _{-0.01} ⁰ _{-0.025}
12.0	⁰ _{-0.01} ⁰ _{-0.025}
16.0	⁰ _{-0.01} ⁰ _{-0.025}
20.0	⁰ _{-0.05}
25.0	⁰ _{-0.05}

Shank(mm) (h6)	d2(mm) tolerance
Ø 3	⁰ _{-0.006}
Ø 4	⁰ _{-0.008}
Ø 6	⁰ _{-0.008}
Ø 8	⁰ _{-0.008}
Ø 10	⁰ _{-0.009}
Ø 12	⁰ _{-0.011}
Ø 16	⁰ _{-0.011}
Ø 20	⁰ _{-0.013}
Ø 25	⁰ _{-0.013}

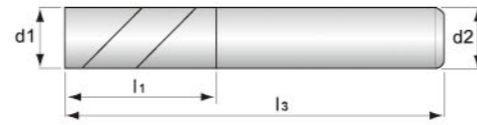

Micro Diameter

Type No. 型號	Diameter 刃徑 d1	Flute Length 刃長 l1	O. A. L. 全長 l3	Shank Dia. 柄徑 d2
SED352010F	1.0	2.5	50	4
SED352015F	1.5	4	50	4
SED352020F	2.0	5	50	4
SED352025F	2.5	7	50	4
SED352030F	3.0	8	50	4
SED352035F	3.5	10	50	4
SED352040F	4.0	10	50	4
SED352045	4.5	13	50	6
SED352050	5.0	13	50	6
SED352055	5.5	13	50	6
SED352060	6.0	15	50	6
SED352065	6.5	15	60	8
SED352070	7.0	17	60	8
SED352075	7.5	17	60	8
SED352080	8.0	20	60	8
SED352085	8.5	25	75	10
SED352090	9.0	25	75	10
SED352095	9.5	25	75	10
SED352100	10.0	25	75	10
SED352105	10.5	25	75	12
SED352110	11.0	28	75	12
SED352115	11.5	28	75	12
SED352120	12.0	30	75	12
SED352130	13.0	33	100	16
SED352140	14.0	35	100	16
SED352150	15.0	38	100	16
SED352160	16.0	40	100	16
SED352170	17.0	40	100	18
SED352180	18.0	40	100	18
SED352190	19.0	45	100	20
SED352200	20.0	45	100	20
SED352250	25.0	45	100	25

Type No. 型號	Diameter 刃徑 d1	Flute Length 刃長 l1	O. A. L. 全長 l3	Shank Dia. 柄徑 d2
SED352010-3	1.0	2.5	50	3
SED352015-3	1.5	4	50	3
SED352020-3	2.0	5	50	3
SED352030-3	3.0	8	50	3
SED352-010	1.0	2.5	50	6
SED352-015	1.5	4	50	6
SED352-020	2.0	5	50	6
SED352-025	2.5	7	50	6
SED352-030	3.0	8	50	6
SED352-035	3.5	10	50	6
SED352-040	4.0	10	50	6

High Speed Cutting
& High Hard Cutting

d1 (mm)	d1 (mm) tolerance
1.0	-0.005 -0.02
1.5	-0.005 -0.02
2.0	-0.005 -0.02
3.0	-0.005 -0.02
4.0	-0.005 -0.02
5.0	-0.005 -0.02
6.0	-0.01 -0.025
8.0	-0.01 -0.025
10.0	-0.01 -0.025
12.0	-0.01 -0.025
16.0	-0.01 -0.025
20.0	0 -0.05
25.0	0 -0.05

Shank (mm) (h6)	d2 (mm) tolerance
Ø 3	0 -0.006
Ø 4	0 -0.008
Ø 6	0 -0.008
Ø 8	0 -0.008
Ø 10	0 -0.009
Ø 12	0 -0.011
Ø 16	0 -0.011
Ø 20	0 -0.013
Ø 25	0 -0.013

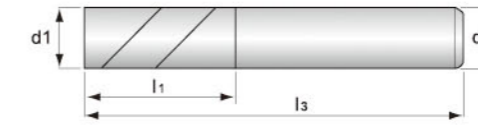

Micro Diameter

Type No. 型號	Diameter 刃徑 d1	Flute Length 刃長 l1	O. A. L. 全長 l3	Shank Dia. 柄徑 d2
SED352010FG	1.0	2.5	50	4
SED352015FG	1.5	4	50	4
SED352020FG	2.0	5	50	4
SED352025FG	2.5	7	50	4
SED352030FG	3.0	8	50	4
SED352035FG	3.5	10	50	4
SED352040FG	4.0	10	50	4
SED352045G	4.5	13	50	6
SED352050G	5.0	13	50	6
SED352055G	5.5	13	50	6
SED352060G	6.0	15	50	6
SED352065G	6.5	15	60	8
SED352070G	7.0	17	60	8
SED352075G	7.5	17	60	8
SED352080G	8.0	20	60	8
SED352085G	8.5	25	75	10
SED352090G	9.0	25	75	10
SED352095G	9.5	25	75	10
SED352100G	10.0	25	75	10
SED352105G	10.5	25	75	12
SED352110G	11.0	28	75	12
SED352115G	11.5	28	75	12
SED352120G	12.0	30	75	12
SED352130G	13.0	33	100	16
SED352140G	14.0	35	100	16
SED352150G	15.0	38	100	16
SED352160G	16.0	40	100	16
SED352170G	17.0	40	100	18
SED352180G	18.0	40	100	18
SED352190G	19.0	45	100	20
SED352200G	20.0	45	100	20
SED352250G	25.0	45	100	25

Type No. 型號	Diameter 刃徑 d1	Flute Length 刃長 l1	O. A. L. 全長 l3	Shank Dia. 柄徑 d2
SED352010-3G	1.0	2.5	50	3
SED352015-3G	1.5	4	50	3
SED352020-3G	2.0	5	50	3
SED352030-3G	3.0	8	50	3
SED352-010G	1.0	2.5	50	6
SED352-015G	1.5	4	50	6
SED352-020G	2.0	5	50	6
SED352-025G	2.5	7	50	6
SED352-030G	3.0	8	50	6
SED352-035G	3.5	10	50	6
SED352-040G	4.0	10	50	6

High Speed Cutting
& High Hard Cutting

d1 (mm)	d1 (mm) tolerance
1.0	-0.005 -0.02
1.5	-0.005 -0.02
2.0	-0.005 -0.02
3.0	-0.005 -0.02
4.0	-0.005 -0.02
5.0	-0.005 -0.02
6.0	-0.01 -0.025
8.0	-0.01 -0.025
10.0	-0.01 -0.025
12.0	-0.01 -0.025
16.0	-0.01 -0.025
20.0	0 -0.05
25.0	0 -0.05

Shank (mm) (h6)	d2 (mm) tolerance
Ø 3	0 -0.006
Ø 4	0 -0.008
Ø 6	0 -0.008
Ø 8	0 -0.008
Ø 10	0 -0.009
Ø 12	0 -0.011
Ø 16	0 -0.011
Ø 20	0 -0.013
Ø 25	0 -0.013

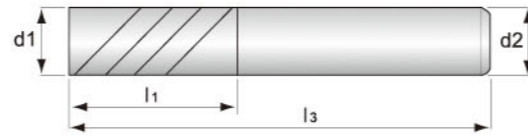
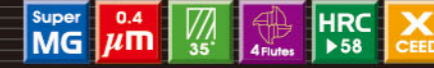
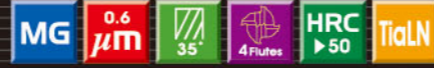

Micro Diameter

Type No. 型號	Diameter 刃徑 d1	Flute Length 刃長 l1	O. A. L. 全長 l3	Shank Dia. 柄徑 d2
354AL010F	1.0	2.5	50	4
354AL015F	1.5	4	50	4
354AL020F	2.0	5	50	4
354AL025F	2.5	7	50	4
354AL030F	3.0	8	50	4
354AL040F	4.0	10	50	4
354AL050	5.0	13	50	6
354AL060	6.0	15	50	6
354AL080	8.0	20	60	8
354AL100	10.0	25	75	10
354AL120	12.0	30	75	12
354AL140	14.0	35	80	14
354AL160	16.0	40	100	16
354AL180	18.0	40	100	18
354AL200	20.0	45	100	20
354AL250	25.0	45	100	25

High Speed Cutting
& High Hard Cutting

d1 (mm)	d1(mm) tolerance
1.0	⁰ _{-0.005} ⁰ _{-0.02}
1.5	⁰ _{-0.005} ⁰ _{-0.02}
2.0	⁰ _{-0.005} ⁰ _{-0.02}
3.0	⁰ _{-0.02}
4.0	⁰ _{-0.02}
5.0	⁰ _{-0.02}
6.0	⁰ _{-0.025}
8.0	⁰ _{-0.025}
10.0	⁰ _{-0.03}
12.0	⁰ _{-0.035}
14.0	⁰ _{-0.04}
16.0	⁰ _{-0.04}
18.0	⁰ _{-0.05}
20.0	⁰ _{-0.05}
25.0	⁰ _{-0.05}

Shank(mm) (h6)	d2(mm) tolerance
Ø 6	⁰ _{-0.008}
Ø 8	⁰ _{-0.008}
Ø 10	⁰ _{-0.009}
Ø 12	⁰ _{-0.011}
Ø 14	⁰ _{-0.011}
Ø 16	⁰ _{-0.011}
Ø 18	⁰ _{-0.013}
Ø 20	⁰ _{-0.013}
Ø 25	⁰ _{-0.013}

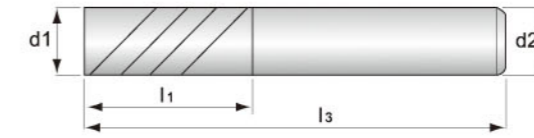

Micro Diameter

Type No. 型號	Diameter 刃徑 d1	Flute Length 刃長 l1	O. A. L. 全長 l3	Shank Dia. 柄徑 d2
SED354010F	1.0	2.5	50	4
SED354015F	1.5	4	50	4
SED354020F	2.0	5	50	4
SED354025F	2.5	7	50	4
SED354030F	3.0	8	50	4
SED354040F	4.0	10	50	4
SED354050	5.0	13	50	6
SED354060	6.0	15	50	6
SED354080	8.0	20	60	8
SED354100	10.0	25	75	10
SED354120	12.0	30	75	12
SED354140	14.0	35	80	14
SED354160	16.0	40	100	16
SED354180	18.0	40	100	18
SED354200	20.0	45	100	20
SED354250	25.0	45	100	25

High Speed Cutting
& High Hard Cutting

Type No. 型號	Diameter 刃徑 d1	Flute Length 刃長 l1	O. A. L. 全長 l3	Shank Dia. 柄徑 d2
SED354010-3	1.0	2.5	50	3
SED354015-3	1.5	4	50	3
SED354020-3	2.0	5	50	3
SED354025-3	2.5	7	50	3
SED354030-3	3.0	8	50	3
SED354-010	1.0	2.5	50	6
SED354-015	1.5	4	50	6
SED354-020	2.0	5	50	6
SED354-025	2.5	7	50	6
SED354-030	3.0	8	50	6
SED352-035	3.5	10	50	6
SED354-040	4.0	10	50	6

d1 (mm)	d1(mm) tolerance
1.0	⁰ _{-0.005} ⁰ _{-0.02}
1.5	⁰ _{-0.005} ⁰ _{-0.02}
2.0	⁰ _{-0.005} ⁰ _{-0.02}
3.0	⁰ _{-0.02}
4.0	⁰ _{-0.02}
5.0	⁰ _{-0.02}
6.0	⁰ _{-0.025}
8.0	⁰ _{-0.025}
10.0	⁰ _{-0.03}
12.0	⁰ _{-0.035}
14.0	⁰ _{-0.04}
16.0	⁰ _{-0.04}
18.0	⁰ _{-0.05}
20.0	⁰ _{-0.05}
25.0	⁰ _{-0.05}

Shank(mm) (h6)	d2(mm) tolerance
Ø 6	⁰ _{-0.008}
Ø 8	⁰ _{-0.008}
Ø 10	⁰ _{-0.009}
Ø 12	⁰ _{-0.011}
Ø 14	⁰ _{-0.011}
Ø 16	⁰ _{-0.011}
Ø 18	⁰ _{-0.013}
Ø 20	⁰ _{-0.013}
Ø 25	⁰ _{-0.013}

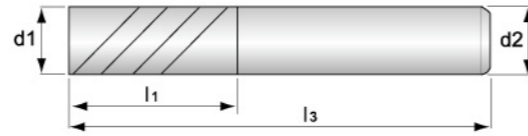

Micro Diameter

Type No. 型號	Diameter 刃徑 d1	Flute Length 刃長 l1	O. A. L. 全長 l3	Shank Dia. 柄徑 d2
SED454010F	1.0	2.5	50	4
SED454015F	1.5	4	50	4
SED454020F	2.0	5	50	4
SED454025F	2.5	7	50	4
SED454030F	3.0	8	50	4
SED454030	3.0	8	50	6
SED454040	4.0	10	50	6
SED454040F	4.0	10	50	4
SED454050	5.0	13	50	6
SED454060	6.0	15	50	6
SED454080	8.0	20	60	8
SED454100	10.0	25	75	10
SED454120	12.0	30	75	12
SED454140	14.0	35	80	14
SED454160	16.0	40	100	16
SED454180	18.0	40	100	18
SED454200	20.0	45	100	20
SED454250	25.0	45	100	25

High Speed Cutting
& High Hard Cutting

d1 (mm)	d1(mm) tolerance
1.0	⁰ _{-0.05}
1.5	⁰ _{-0.02}
2.0	⁰ _{-0.05}
3.0	⁰ _{-0.02}
4.0	⁰ _{-0.02}
5.0	⁰ _{-0.02}
6.0	⁰ _{-0.025}
8.0	⁰ _{-0.025}
10.0	⁰ _{-0.03}
12.0	⁰ _{-0.035}
14.0	⁰ _{-0.04}
16.0	⁰ _{-0.04}
18.0	⁰ _{-0.05}
20.0	⁰ _{-0.05}
25.0	⁰ _{-0.05}

Shank(mm) (h6)	d2(mm) tolerance
Ø 6	⁰ _{-0.008}
Ø 8	⁰ _{-0.008}
Ø 10	⁰ _{-0.009}
Ø 12	⁰ _{-0.011}
Ø 14	⁰ _{-0.011}
Ø 16	⁰ _{-0.011}
Ø 18	⁰ _{-0.013}
Ø 20	⁰ _{-0.013}
Ø 25	⁰ _{-0.013}

$$N = \frac{VC \times 320}{D} \quad F = N \times Fz \times \text{刃數 (Flute No)}$$

Recommended Working Details 白鐵加工數據表

Material	Vc m/min	Fz - feed per tooth									
		ø4	ø5	ø6	ø8	ø10	ø12	ø16	ø18	ø20	ø25
Easy to Cut Steel(304)	90-115	0.015	0.015	0.020	0.030	0.030	0.040	0.050	0.060	0.060	0.060
Moderately difficult to cut Stainless Steels	70-85	0.013	0.013	0.018	0.028	0.028	0.038	0.053	0.058	0.058	0.058
Difficult to cut Stainless Steels (316L)	60-80	0.011	0.011	0.016	0.026	0.026	0.036	0.051	0.056	0.056	0.056
High Temperature Alloy	25-35	0.011	0.011	0.017	0.027	0.027	0.038	0.055	0.060	0.060	0.060
Soft Steels	150-180	0.020	0.020	0.020	0.030	0.030	0.040	0.060	0.060	0.060	0.060
Titanium	50-70	0.012	0.020	0.016	0.022	0.022	0.033	0.044	0.055	0.055	0.055
Gray Cast Iron	120-150	0.015	0.020	0.020	0.030	0.030	0.040	0.060	0.060	0.060	0.060

Material	Profiling		Slotting depth	Performance
	a	b	c	
Easy to Cut Steel(304)	D	50%D	D	Excellent
Moderately difficult to cut Stainless Steels	D	50%D	D	Excellent
Difficult to cut Stainless Steels (316L)	D	50%D	D	Excellent
High Temperature Alloy	D	20%D	30%D	Excellent
Soft Steels	D	50%D	D	Excellent
Titanium	D	20%D	20%D	Recommended for side milling fz x 1.2
Gray Cast Iron	D	50%D	D	Recommended for side milling fz x 1.2

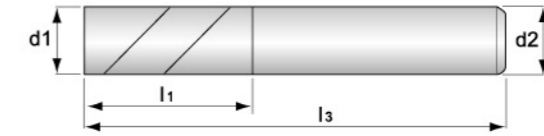

Micro Diameter

Type No. 型號	Diameter 刃徑 d1	Flute Length 刃長 l1	O. A. L. 全長 l3	Shank Dia. 柄徑 d2
35L2AL010F	1.0	4	75	4
35L2AL015F	1.5	6	75	4
35L2AL020F	2.0	8	75	4
35L2AL025F	2.5	10	75	4
35L2AL030F	3.0	12	75	4
35L2AL040F	4.0	16	75	4
35L2AL020	2.0	8	75	6
35L2AL030	3.0	12	75	6
35L2AL040	4.0	16	75	6
35L2AL050	5.0	20	75	6
35L2AL060	6.0	25	75	6
35L2AL080	8.0	25	75	8
35SL2AL040FB	4.0	16	100	4
35L2AL050B	5.0	25	100	6
35L2AL060B	6.0	25	100	6
35L2AL080B	8.0	35	100	8
35L2AL100	10.0	40	100	10
35L2AL120	12.0	45	100	12
35SL2AL060	6.0	25	150	6
35SL2AL080	8.0	35	150	8
35SL2AL100	10.0	40	150	10
35SL2AL120	12.0	45	150	12
35SL2AL160	16.0	65	150	16
35SL2AL200	20.0	75	150	20



High Speed Cutting
& High Hard Cutting

d1 (mm)	d1(mm) tolerance
2.0	⁰ _{-0.02}
3.0	⁰ _{-0.02}
4.0	⁰ _{-0.02}
5.0	⁰ _{-0.02}
6.0	⁰ _{-0.025}
8.0	⁰ _{-0.03}
10.0	⁰ _{-0.035}
12.0	⁰ _{-0.04}
16.0	⁰ _{-0.04}
20.0	⁰ _{-0.05}

Shank(mm) (h6)	d2(mm) tolerance
Ø 4	⁰ _{-0.008}
Ø 6	⁰ _{-0.008}
Ø 8	⁰ _{-0.008}
Ø 10	⁰ _{-0.009}
Ø 12	⁰ _{-0.011}
Ø 16	⁰ _{-0.011}
Ø 20	⁰ _{-0.013}

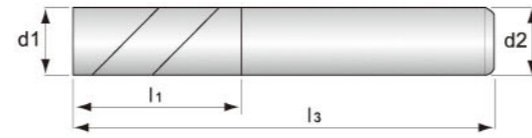

Micro Diameter

Type No. 型號	Diameter 刃徑 d1	Flute Length 刃長 l1	O. A. L. 全長 l3	Shank Dia. 柄徑 d2
SED35L2-010F	1.0	4	75	4
SED35L2-015F	1.5	6	75	4
SED35L2-020F	2.0	8	75	4
SED35L2-025F	2.5	10	75	4
SED35L2-030F	3.0	12	75	4
SED35L2-040F	4.0	16	75	4
SED35L2-020	2.0	8	75	6
SED35L2-030	3.0	12	75	6
SED35L2-040	4.0	16	75	6
SED35L2-050	5.0	20	75	6
SED35L2-060	6.0	25	75	6
SED35L2-080	8.0	25	75	8
SED35L2-040FB	4.0	16	100	4
SED35L2-050B	5.0	25	100	6
SED35L2-060B	6.0	25	100	6
SED35L2-080B	8.0	35	100	8
SED35L2-100	10.0	40	100	10
SED35L2-120	12.0	45	100	12
SED35SL2-060	6.0	25	150	6
SED35SL2-080	8.0	35	150	8
SED35SL2-100	10.0	40	150	10
SED35SL2-120	12.0	45	150	12
SED35SL2-160	16.0	65	150	16
SED35SL2-200	20.0	75	150	20

High Speed Cutting
& High Hard Cutting

d1 (mm)	d1(mm) tolerance
2.0	0 -0.02
3.0	0 -0.02
4.0	0 -0.02
5.0	0 -0.02
6.0	0 -0.025
8.0	0 -0.03
10.0	0 -0.035
12.0	0 -0.04
16.0	0 -0.04
20.0	0 -0.05

Shank(mm) (h6)	d2(mm) tolerance
Ø 4	0 -0.008
Ø 6	0 -0.008
Ø 8	0 -0.008
Ø 10	0 -0.009
Ø 12	0 -0.011
Ø 16	0 -0.011
Ø 20	0 -0.013

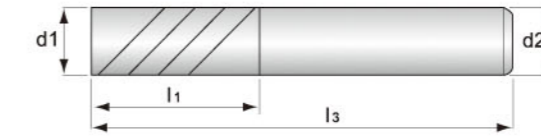

Micro Diameter

Type No. 型號	Diameter 刃徑 d1	Flute Length 刃長 l1	O. A. L. 全長 l3	Shank Dia. 柄徑 d2
35L4AL010F	1.0	4	75	4
35L4AL015F	1.5	6	75	4
35L4AL020F	2.0	8	75	4
35L4AL025F	2.5	10	75	4
35L4AL030F	3.0	12	75	4
35L4AL040F	4.0	16	75	4
35L4AL020	2.0	8	75	6
35L4AL030	3.0	12	75	6
35L4AL040	4.0	16	75	6
35L4AL050	5.0	20	75	6
35L4AL060	6.0	25	75	6
35L4AL080	8.0	25	75	8
35L4AL040FB	4.0	16	100	4
35L4AL050B	5.0	25	100	6
35L4AL060B	6.0	25	100	6
35L4AL080B	8.0	35	100	8
35L4AL100	10.0	40	100	10
35L4AL120	12.0	45	100	12
35SL4AL060	6.0	25	150	6
35SL4AL080	8.0	35	150	8
35SL4AL100	10.0	40	150	10
35SL4AL120	12.0	45	150	12
35SL4AL160	16.0	65	150	16
35SL4AL200	20.0	75	150	20



High Speed Cutting
& High Hard Cutting

d1 (mm)	d1(mm) tolerance
2.0	0 -0.02
3.0	0 -0.02
4.0	0 -0.02
5.0	0 -0.02
6.0	0 -0.025
8.0	0 -0.03
10.0	0 -0.035
12.0	0 -0.04
16.0	0 -0.04
20.0	0 -0.05

Shank(mm) (h6)	d2(mm) tolerance
Ø 4	0 -0.008
Ø 6	0 -0.008
Ø 8	0 -0.008
Ø 10	0 -0.009
Ø 12	0 -0.011
Ø 16	0 -0.011
Ø 20	0 -0.013

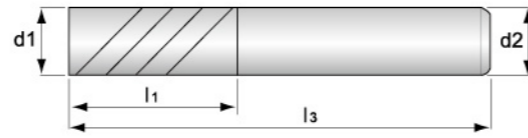

Micro Diameter

Type No. 型號	Diameter 刃徑 d1	Flute Length 刃長 l1	O. A. L. 全長 l3	Shank Dia. 柄徑 d2
SED35L4-010F	1.0	4	75	4
SED35L4-015F	1.5	6	75	4
SED35L4-020F	2.0	8	75	4
SED35L4-025F	2.5	10	75	4
SED35L4-030F	3.0	12	75	4
SED35L4-040F	4.0	16	75	4
SED35L4-020	2.0	8	75	6
SED35L4-030	3.0	12	75	6
SED35L4-040	4.0	16	75	6
SED35L4-050	5.0	20	75	6
SED35L4-060	6.0	25	75	6
SED35L4-080	8.0	25	75	8
SED35L4-040FB	4.0	16	100	4
SED35L4-050B	5.0	25	100	6
SED35L4-060B	6.0	25	100	6
SED35L4-080B	8.0	35	100	8
SED35L4-100	10.0	40	100	10
SED35L4-120	12.0	45	100	12
SED35SL4-060	6.0	25	150	6
SED35SL4-080	8.0	35	150	8
SED35SL4-100	10.0	40	150	10
SED35SL4-120	12.0	45	150	12
SED35SL4-160	16.0	65	150	16
SED35SL4-200	20.0	75	150	20

High Speed Cutting
& High Hard Cutting

d1 (mm)	d1(mm) tolerance
2.0	0 -0.02
3.0	0 -0.02
4.0	0 -0.02
5.0	0 -0.02
6.0	0 -0.025
8.0	0 -0.03
10.0	0 -0.035
12.0	0 -0.04
16.0	0 -0.04
20.0	0 -0.05

Shank(mm) (h6)	d2(mm) tolerance
Ø 4	0 -0.008
Ø 6	0 -0.008
Ø 8	0 -0.008
Ø 10	0 -0.009
Ø 12	0 -0.011
Ø 16	0 -0.011
Ø 20	0 -0.013

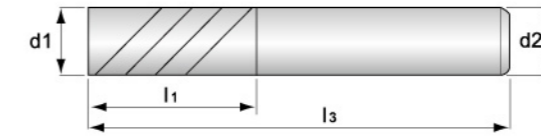

Micro Diameter

Type No. 型號	Diameter 刃徑 d1	Flute Length 刃長 l1	O. A. L. 全長 l3	Shank Dia. 柄徑 d2
45L4AL010F	1.0	4	75	4
45L4AL015F	1.5	6	75	4
45L4AL020F	2.0	8	75	4
45L4AL025F	2.5	10	75	4
45L4AL030	3.0	12	75	6
45L4AL040	4.0	16	75	6
45L4AL050	5.0	20	75	6
45L4AL060	6.0	25	75	6
45L4AL080	8.0	25	75	8
45L4AL060B	6.0	25	100	6
45L4AL080B	8.0	35	100	8
45L4AL100	10.0	40	100	10
45L4AL120	12.0	45	100	12
45SL4AL060	6.0	25	150	6
45SL4AL080	8.0	35	150	8
45SL4AL100	10.0	40	150	10
45SL4AL120	12.0	45	150	12
45SL4AL160	16.0	65	150	16
45SL4AL200	20.0	75	150	20



High Speed Cutting
& High Hard Cutting

d1 (mm)	d1(mm) tolerance
2.0	0 -0.02
3.0	0 -0.02
4.0	0 -0.02
5.0	0 -0.02
6.0	0 -0.025
8.0	0 -0.03
10.0	0 -0.035
12.0	0 -0.04
16.0	0 -0.04
20.0	0 -0.05

Shank(mm) (h6)	d2(mm) tolerance
Ø 4	0 -0.008
Ø 6	0 -0.008
Ø 8	0 -0.008
Ø 10	0 -0.009
Ø 12	0 -0.011
Ø 16	0 -0.011
Ø 20	0 -0.013

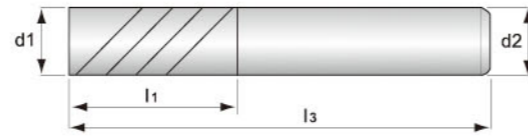
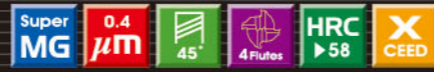

Micro Diameter

Type No. 型號	Diameter 刃徑 d1	Flute Length 刃長 l1	O. A. L. 全長 l3	Shank Dia. 柄徑 d2
SED45L4-010F	1.0	4	75	4
SED45L4-015F	1.5	6	75	4
SED45L4-020F	2.0	8	75	4
SED45L4-025F	2.5	10	75	4
SED45L4-030	3.0	12	75	6
SED45L4-040	4.0	16	75	6
SED45L4-050	5.0	20	75	6
SED45L4-060	6.0	25	75	6
SED45L4-080	8.0	25	75	8
SED45L4-060B	6.0	25	100	6
SED45L4-080B	8.0	35	100	8
SED45L4-100	10.0	40	100	10
SED45L4-120	12.0	45	100	12
SED45SL4-060	6.0	25	150	6
SED45SL4-080	8.0	35	150	8
SED45SL4-100	10.0	40	150	10
SED45SL4-120	12.0	45	150	12
SED45SL4-160	16.0	65	150	16
SED45SL4-200	20.0	75	150	20

High Speed Cutting
& High Hard Cutting

d1 (mm)	d1(mm) tolerance
2.0	⁰ / _{-0.02}
3.0	⁰ / _{-0.02}
4.0	⁰ / _{-0.02}
5.0	⁰ / _{-0.02}
6.0	⁰ / _{-0.025}
8.0	⁰ / _{-0.03}
10.0	⁰ / _{-0.035}
12.0	⁰ / _{-0.04}
16.0	⁰ / _{-0.04}
20.0	⁰ / _{-0.05}

Shank(mm) (h6)	d2(mm) tolerance
Ø 4	⁰ / _{-0.008}
Ø 6	⁰ / _{-0.008}
Ø 8	⁰ / _{-0.008}
Ø 10	⁰ / _{-0.009}
Ø 12	⁰ / _{-0.011}
Ø 16	⁰ / _{-0.011}
Ø 20	⁰ / _{-0.013}

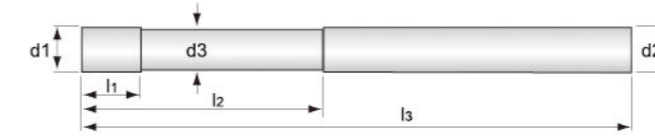

Micro Diameter

Type No. 型號	Diameter 刃徑 d1	Neck Dia d3	Flute Length 刃長 l1	Effective Length 有效長 l2	O. A. L. 全長 l3	Shank Dia. 柄徑 d2
SEDHAL020	2.0	1.92	3	8	50	4
SEDHAL025	2.5	2.40	3	10	50	4
SEDHAL030	3.0	2.90	4	10	50	4
SEDHAL040	4.0	3.90	6	12	50	4
SEDHAL050	5.0	4.90	7	15	50	6
SEDHAL060	6.0	5.80	8	18	50	6
SEDHAL080	8.0	7.70	10	24	60	8
SEDHAL100	10.0	9.60	12	30	75	10
SEDHAL120	12.0	11.50	15	36	75	12
SEDHAL160	16.0	15.50	24	40	100	16
SEDHAL200	20.0	19.50	30	45	100	20

New



High Speed Cutting
& High Hard Cutting

d1 (mm)	d1(mm) tolerance
2.0	⁰ / _{-0.02}
3.0	⁰ / _{-0.02}
4.0	⁰ / _{-0.02}
5.0	⁰ / _{-0.02}
6.0	⁰ / _{-0.025}
8.0	⁰ / _{-0.03}
10.0	⁰ / _{-0.035}
12.0	⁰ / _{-0.04}
16.0	⁰ / _{-0.04}
20.0	⁰ / _{-0.05}

Shank(mm) (h6)	d2(mm) tolerance
Ø 4	⁰ / _{-0.008}
Ø 6	⁰ / _{-0.008}
Ø 8	⁰ / _{-0.008}
Ø 10	⁰ / _{-0.009}
Ø 12	⁰ / _{-0.011}
Ø 16	⁰ / _{-0.011}
Ø 20	⁰ / _{-0.013}



重切削 4刃立銑刀
Heavy Cutting, 4-flute, End Mills



極細微粒碳化鎢 6刃立銑刀
Micro Grain Carbide, 6-flute, End Mills

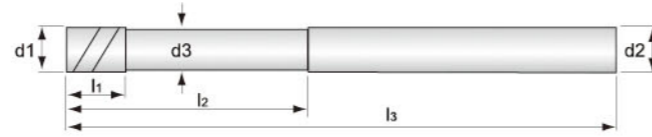
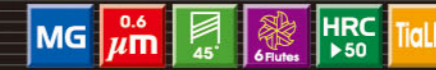

Micro Diameter

Type No. 型號	Diameter 刃徑 d1	Neck Dia d3	Flute Length 刃長 l1	Effective Length 有效長 l2	O. A. L. 全長 l3	Shank Dia. 柄徑 d2
SEDH-020	2.0	1.92	3	8	50	4
SEDH-025	2.5	2.40	3	10	50	4
SEDH-030	3.0	2.90	4	10	50	4
SEDH-040	4.0	3.90	6	12	50	4
SEDH-050	5.0	4.90	7	15	50	6
SEDH-060	6.0	5.80	8	18	50	6
SEDH-080	8.0	7.70	10	24	60	8
SEDH-100	10.0	9.60	12	30	75	10
SEDH-120	12.0	11.50	15	36	75	12
SEDH-160	16.0	15.50	24	40	100	16
SEDH-200	20.0	19.50	30	45	100	20

New

High Speed Cutting
& High Hard Cutting

d1 (mm)	d1 (mm) tolerance
2.0	0 -0.02
3.0	0 -0.02
4.0	0 -0.02
5.0	0 -0.02
6.0	0 -0.025
8.0	0 -0.03
10.0	0 -0.035
12.0	0 -0.04
16.0	0 -0.04
20.0	0 -0.05

Shank(mm) (h6)	d2(mm) tolerance
Ø 4	0 -0.008
Ø 6	0 -0.008
Ø 8	0 -0.008
Ø 10	0 -0.009
Ø 12	0 -0.011
Ø 16	0 -0.011
Ø 20	0 -0.013

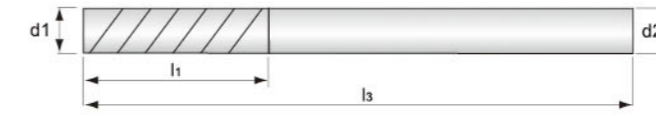

Micro Diameter

Type No. 型號	Diameter 刃徑 d1	Flute Length 刃長 l1	O. A. L. 全長 l3	Shank Dia. 柄徑 d2
6SEDAL060	6.0	15	50	6
6SEDAL080	8.0	20	60	8
6SEDAL100	10.0	25	75	10
6SEDAL120	12.0	30	75	12
6SEDAL160	16.0	40	100	16
6SEDAL200	20.0	40	100	20



High Speed Cutting
& High Hard Cutting



極細微粒碳化鎢 6刃立銑刀
Micro Grain Carbide, 6-flute, End Mills



Type No. 型號	Diameter 刃徑 d1	Flute Length 刃長 l1	O. A. L. 全長 l3	Shank Dia. 柄徑 d2
6SED060	6.0	15	50	6
6SED080	8.0	20	60	8
6SED100	10.0	25	75	10
6SED120	12.0	30	75	12
6SED160	16.0	40	100	16
6SED200	20.0	40	100	20

d1 (mm)	d1 (mm) tolerance
6.0	0 -0.025
8.0	0 -0.03
10.0	0 -0.035
12.0	0 -0.04
16.0	0 -0.04
20.0	0 -0.013

Shank(mm) (h6)	d2(mm) tolerance
Ø 6	0 -0.008
Ø 8	0 -0.008
Ø 10	0 -0.009
Ø 12	0 -0.011
Ø 16	0 -0.011
Ø 20	0 -0.013

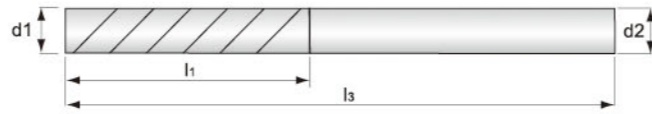
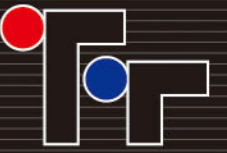

Micro Diameter

Type No. 型號	Diameter 刃徑 d1	Flute Length 刃長 l1	O. A. L. 全長 l3	Shank Dia. 柄徑 d2
L6SEDAL060	6.0	25	75	6
L6SEDAL060B	6.0	30	100	6
L6SEDAL080B	8.0	35	100	8
L6SEDAL100	10.0	40	100	10
L6SEDAL100B	10.0	40	150	10
L6SEDAL120	12.0	45	100	12
L6SEDAL120B	12.0	45	150	12
L6SEDAL160B	16.0	60	150	16
L6SEDAL200B	20.0	80	150	20

High Speed Cutting
& High Hard Cutting

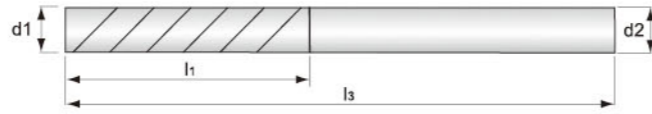

Micro Diameter

Type No. 型號	Diameter 刃徑 d1	Flute Length 刃長 l1	O. A. L. 全長 l3	Shank Dia. 柄徑 d2
L6SED060	6.0	25	75	6
L6SED060B	6.0	30	100	6
L6SED080B	8.0	35	100	8
L6SED100	10.0	40	100	10
L6SED100B	10.0	40	150	10
L6SED120	12.0	45	100	12
L6SED120B	12.0	45	150	12
L6SED160B	16.0	60	150	16
L6SED200B	20.0	80	150	20

d1 (mm)	d1 (mm) tolerance
6.0	0 -0.025
8.0	0 -0.03
10.0	0 -0.035
12.0	0 -0.04
16.0	0 -0.04
20.0	0 -0.013

Shank (mm) (h6)	d2 (mm) tolerance
Ø 6	0 -0.008
Ø 8	0 -0.008
Ø 10	0 -0.009
Ø 12	0 -0.011
Ø 16	0 -0.011
Ø 20	0 -0.013

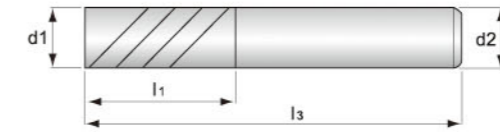

Micro Diameter

Type No. 型號	Diameter 刃徑 d1	Flute Length 刃長 l1	O. A. L. 全長 l3	Shank Dia. 柄徑 d2
SED453030	3	8	50	6
SED453040	4	10	50	6
SED453050	5	13	50	6
SED453060	6	15	50	6
SED453080	8	20	60	8
SED453100	10	25	75	10
SED453120	12	30	75	12
SED453160	16	40	100	16

New



High Speed Cutting
& High Hard Cutting

d1 (mm)	d1 (mm) tolerance
1.0	0 -0.005 -0.02
1.5	0 -0.005 -0.02
2.0	0 -0.005 -0.02
3.0	0 -0.02
4.0	0 -0.02
5.0	0 -0.02
6.0	0 -0.025
8.0	0 -0.025
10.0	0 -0.03
12.0	0 -0.035
14.0	0 -0.04
16.0	0 -0.04

Shank (mm) (h6)	d2 (mm) tolerance
Ø 6	0 -0.008
Ø 8	0 -0.008
Ø 10	0 -0.009
Ø 12	0 -0.011
Ø 14	0 -0.011
Ø 16	0 -0.011



極細微粒碳化鎢 4刃粗銑立銑刀
Micro Grain Carbide, 4-flute, Roughing, End Mills



極細微粒碳化鎢 2刃球型立銑刀 (高速高硬度專用刀)
Micro Grain Carbide, 2-flute, Ball End Mills (Sword for High-speed and High-hardness)

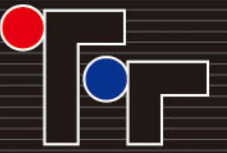

High Speed Cutting
& High Hard Cutting

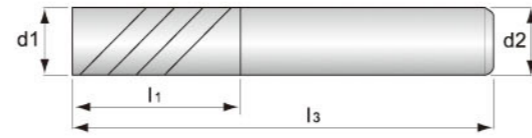

Micro Diameter

Type No. 型號	Diameter 刃徑 d1	Flute Length 刃長 l1	O. A. L. 全長 l3	Shank Dia. 柄徑 d2
FREAL060	6.0	16	50	6
FREAL080	8.0	20	60	8
FREAL100	10.0	25	75	10
FREAL120	12.0	30	75	12
FREAL140	14.0	35	100	16
FREAL160	16.0	40	100	16
FREAL180	18.0	40	100	20
FREAL200	20.0	45	100	20

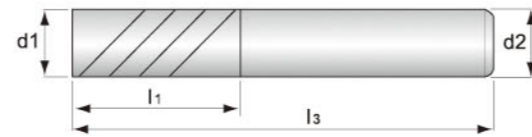

極細微粒碳化鎢 4刃粗銑立銑刀
Micro Grain Carbide, 4-flute, Roughing, End Mills



Micro Diameter

Type No. 型號	Diameter 刃徑 d1	Flute Length 刃長 l1	O. A. L. 全長 l3	Shank Dia. 柄徑 d2
FRE060	6.0	16	50	6
FRE080	8.0	20	60	8
FRE100	10.0	25	75	10
FRE120	12.0	30	75	12
FRE140	14.0	35	100	16
FRE160	16.0	40	100	16
FRE180	18.0	40	100	20
FRE200	20.0	45	100	20

Shank(mm) (h6)	d2(mm) tolerance
Ø 6	⁰ / _{-0.008}
Ø 8	⁰ / _{-0.008}
Ø 10	⁰ / _{-0.009}
Ø 12	⁰ / _{-0.011}
Ø 16	⁰ / _{-0.011}
Ø 20	⁰ / _{-0.013}

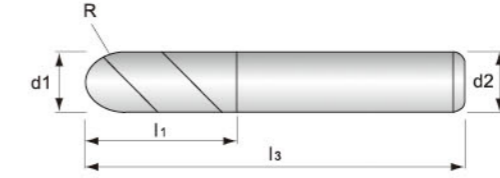

Micro Diameter

Type No. 型號	Diameter 刃徑 d1	Flute Length 刃長 l1	O. A. L. 全長 l3	Shank Dia. 柄徑 d2
MR2010G	R 0.5	2	50	4
MR2015G	R 0.75	3	50	4
MR2020G	R 1.0	4	50	4
MR2025G	R 1.25	5	50	4
MR2030G	R 1.5	6	50	4
MR2035G	R 1.75	7	50	4
MR2040G	R 2.0	8	50	4
MR2045G	R 2.25	9	50	6
MR2050G	R 2.5	10	50	6
MR2055G	R 2.75	11	50	6
MR2060G	R 3.0	12	50	6
MR2065G	R 3.25	12	60	8
MR2070G	R 3.5	12	60	8
MR2075G	R 3.75	14	60	8
MR2080G	R 4.0	16	60	8
MR2090G	R 4.5	18	75	10
MR2100G	R 5.0	20	75	10
MR2120G	R 6.0	24	75	12
MR2160G	R 8.0	32	100	16
MR2200G	R 10.0	40	100	20



High Speed Cutting
& High Hard Cutting

d1 (mm)	d1(mm) tolerance
R1	±0.01
R1.5	±0.01
R2	±0.01
R2.5	±0.01
R3	±0.01
R4	±0.01
R5	±0.01
R6	±0.015
R8	±0.02
R10	±0.02

Shank(mm) (h6)	d2(mm) tolerance
Ø 4	⁰ / _{-0.008}
Ø 6	⁰ / _{-0.008}
Ø 8	⁰ / _{-0.008}
Ø 10	⁰ / _{-0.009}
Ø 12	⁰ / _{-0.011}
Ø 16	⁰ / _{-0.011}
Ø 20	⁰ / _{-0.013}



High Speed Cutting
& High Hard Cutting

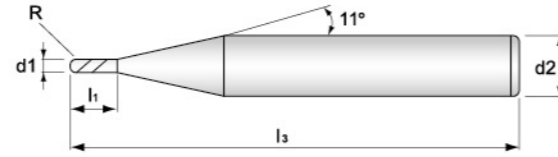

Micro Diameter

Type No. 型號	Diameter 刃徑 d1	Flute Length 刃長 l1	O. A. L. 全長 l3	Shank Dia. 柄徑 d2
MR2002-3	R 0.10	0.4	50	3
MR2003-3	R 0.15F	0.6	50	3
MR2004-3	R 0.20F	0.8	50	3
MR2005-3	R 0.25F	1.0	50	3
MR2006-3	R 0.30F	1.2	50	3
MR2007-3	R 0.35F	1.4	50	3
MR2008-3	R 0.40F	1.6	50	3
MR2009-3	R 0.45F	1.8	50	3
MR2002	R 0.10	0.4	50	4
MR2003	R 0.15	0.6	50	4
MR2004	R 0.20	0.8	50	4
MR2005	R 0.25	1.0	50	4
MR2006	R 0.30	1.2	50	4
MR2007	R 0.35	1.4	50	4
MR2008	R 0.40	1.6	50	4
MR2009	R 0.45	1.8	50	4
MR2012	R 0.60	2.4	50	4
MR2014	R 0.70	2.8	50	4
MR2016	R 0.80	3.2	50	4
MR2018	R 0.90	3.6	50	4

d1 (mm)	d1 (mm) tolerance
R0.1	±0.01
R0.15	±0.01
R0.2	±0.01
R.025	±0.01
R0.3	±0.01
R0.35	±0.01
R0.4	±0.01
R0.5	±0.01
R0.75	±0.01
R1.0	±0.01
R1.5	±0.01
R2.0	±0.01

Shank(mm) (h6)	d2(mm) tolerance
Ø 3	0 -0.006
Ø 4	0 -0.008

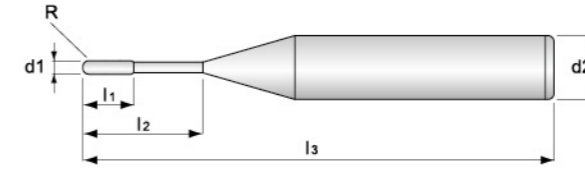

Micro Diameter

Type No. 型號	Diameter R徑 d1	Flute Length 刃長 l1	Effective Length 有效長 l2	O. A. L. 全長 l3	Shank Dia. 柄徑 d2
HMR20402	R 0.2	0.6	2	50	4
HMR20404	R 0.2	0.6	4	50	4
HMR20502	R 0.25	0.8	2	50	4
HMR20504	R 0.25	0.8	4	50	4
HMR20506	R 0.25	0.8	6	50	4
HMR20602	R 0.3	1.0	2	50	4
HMR20604	R 0.3	1.0	4	50	4
HMR20606	R 0.3	1.0	6	50	4
HMR20608	R 0.3	1.0	8	50	4
HMR20804	R 0.4	1.2	4	50	4
HMR20806	R 0.4	1.2	6	50	4
HMR20808	R 0.4	1.2	8	50	4
HMR20810	R 0.4	1.2	10	50	4
HMR21004	R 0.5	1.2	4	50	4
HMR21006	R 0.5	1.2	6	50	4
HMR21008	R 0.5	1.2	8	50	4
HMR21010	R 0.5	1.2	10	50	4
HMR21012	R 0.5	1.2	12	50	4
HMR21504	R 0.75	1.7	4	50	4
HMR21506	R 0.75	1.7	6	50	4
HMR21508	R 0.75	1.7	8	50	4
HMR21510	R 0.75	1.7	10	50	4
HMR21512	R 0.75	1.7	12	50	4
HMR22006	R 1.0	2.2	6	50	4
HMR22008	R 1.0	2.2	8	50	4
HMR22010	R 1.0	2.2	10	50	4
HMR22012	R 1.0	2.2	12	50	4
HMR22014	R 1.0	2.2	14	50	4
HMR22016	R 1.0	2.2	16	50	4
HMR23008	R 1.5	3.2	8	50	4
HMR23010	R 1.5	3.2	10	50	4
HMR23012	R 1.5	3.2	12	50	4
HMR23014	R 1.5	3.2	14	50	4
HMR23016	R 1.5	3.2	16	75	4
HMR23020	R 1.5	3.2	20	75	4
HMR24012-6	R 2.0	4.2	12	75	6
HMR24014-6	R 2.0	4.2	14	75	6
HMR24016-6	R 2.0	4.2	16	75	6
HMR24020-6	R 2.0	4.2	20	75	6
HMR24025-6	R 2.0	4.2	25	75	6

High Speed Cutting
& High Hard Cutting



d1 (mm)	d1 (mm) tolerance
R0.25	±0.01
R0.3	±0.01
R0.4	±0.01
R0.5	±0.01
R0.75	±0.01
R1.0	±0.01
R1.5	±0.01
R2.0	±0.01

Shank(mm) (h6)	d2(mm) tolerance
Ø 4	0 -0.008
Ø 6	0 -0.008



High Speed Cutting
& High Hard Cutting

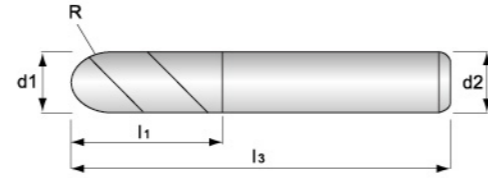

Micro Diameter

Type No. 型號	Diameter 刃徑 d1	Flute Length 刃長 l1	O. A. L. 全長 l3	Shank Dia. 柄徑 d2
MR2AL010	R 0.5	2	50	4
MR2AL015	R 0.75	3	50	4
MR2AL020	R 1.0	4	50	4
MR2AL025	R 1.25	5	50	4
MR2AL030	R 1.5	6	50	4
MR2AL035	R 1.75	7	50	4
MR2AL040	R 2.0	8	50	4
MR2AL045-6	R 2.25	9	50	6
MR2AL050-6	R 2.5	10	50	6
MR2AL055-6	R 2.75	11	50	6
MR2AL060-6	R 3.0	12	50	6
MR2AL065	R 3.25	12	60	8
MR2AL070	R 3.5	12	60	8
MR2AL075	R 3.75	14	60	8
MR2AL080	R 4.0	16	60	8
MR2AL090	R 4.5	18	75	10
MR2AL100	R 5.0	20	75	10
MR2AL120	R 6.0	24	75	12
MR2AL160	R 8.0	32	100	16
MR2AL200	R 10.0	40	100	20

Type No. 型號	Diameter 刃徑 d1	Flute Length 刃長 l1	O. A. L. 全長 l3	Shank Dia. 柄徑 d2
MR2AL010-3	R 0.5	2	50	3
MR2AL015-3	R 0.75	3	50	3
MR2AL020-3	R 1.0	4	50	3
MR2AL025-3	R 1.25	5	50	3
MR2AL030-3	R 1.5	6	50	3
MR60AL010	R 0.5	2	50	6
MR60AL015	R 0.75	3	50	6
MR60AL020	R 1.0	4	50	6
MR60AL030	R 1.5	6	50	6
MR60AL040	R 2.0	8	50	6

d1 (mm)	d1(mm) tolerance
R1	±0.01
R1.5	±0.01
R2	±0.01
R2.5	±0.01
R3	±0.01
R4	±0.01
R5	±0.01
R6	±0.015
R8	±0.02
R10	±0.02

Shank(mm) (h6)	d2(mm) tolerance
Ø 6	0 -0.008
Ø 8	0 -0.008
Ø 10	0 -0.009
Ø 12	0 -0.011
Ø 16	0 -0.011
Ø 20	0 -0.013

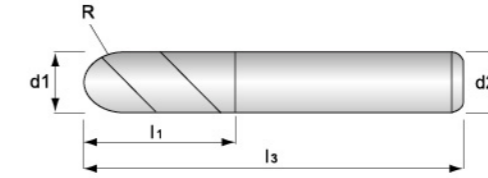

Micro Diameter

Type No. 型號	Diameter 刃徑 d1	Flute Length 刃長 l1	O. A. L. 全長 l3	Shank Dia. 柄徑 d2
MR2010	R 0.5	2	50	4
MR2015	R 0.75	3	50	4
MR2020	R 1.0	4	50	4
MR2025	R 1.25	5	50	4
MR2030	R 1.5	6	50	4
MR2035	R 1.75	7	50	4
MR2040	R 2.0	8	50	4
MR2045-6	R 2.25	9	50	6
MR2050-6	R 2.5	10	50	6
MR2055-6	R 2.75	11	50	6
MR2060-6	R 3.0	12	50	6
MR2065	R 3.25	12	60	8
MR2070	R 3.5	12	60	8
MR2075	R 3.75	14	60	8
MR2080	R 4.0	16	60	8
MR2090	R 4.5	18	75	10
MR2100	R 5.0	20	75	10
MR2120	R 6.0	24	75	12
MR2160	R 8.0	32	100	16
MR2200	R 10.0	40	100	20

Type No. 型號	Diameter 刃徑 d1	Flute Length 刃長 l1	O. A. L. 全長 l3	Shank Dia. 柄徑 d2
MR010-3	R 0.5	2	50	3
MR015-3	R 0.75	3	50	3
MR020-3	R 1.0	4	50	3
MR025-3	R 1.25	5	50	3
MR030-3	R 1.5	6	50	3
MR60010	R 0.5	2	50	6
MR60015	R 0.75	3	50	6
MR60020	R 1.0	4	50	6
MR60030	R 1.5	6	50	6
MR60040	R 2.0	8	50	6

High Speed Cutting
& High Hard Cutting

d1 (mm)	d1(mm) tolerance
R1	±0.01
R1.5	±0.01
R2	±0.01
R2.5	±0.01
R3	±0.01
R4	±0.01
R5	±0.01
R6	±0.015
R8	±0.02
R10	±0.02

Shank(mm) (h6)	d2(mm) tolerance
Ø 6	0 -0.008
Ø 8	0 -0.008
Ø 10	0 -0.009
Ø 12	0 -0.011
Ø 16	0 -0.011
Ø 20	0 -0.013

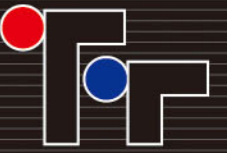
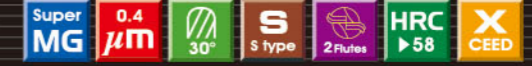
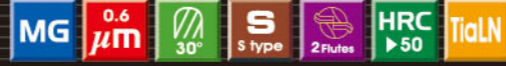

High Speed Cutting
& High Hard Cutting

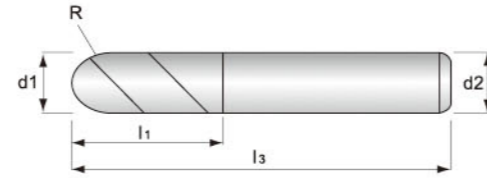

Micro Diameter

Type No. 型號	Diameter R	Flute Length 刃長 l ₁	O. A. L. 全長 l ₃	Shank Dia. 柄徑 d ₂
LR2AL010F	R 0.5	2	75	4
LR2AL015F	R 0.75	3	75	4
LR2AL020F	R 1	4	75	4
LR2AL030F	R 1.5	6	75	4
LR2AL040F	R 2	8	75	4
LR2AL010-75-6	R 0.5	2	75	6
LR2AL015-75-6	R 0.75	3	75	6
LR2AL020-75-6	R 1	4	75	6
LR2AL030-75-6	R 1.5	6	75	6
LR2AL040-75-6	R 2	8	75	6
LR2AL050-75-6	R 2.5	10	75	6
LR2AL060-75-6	R 3	12	75	6
LR2AL080-75	R 4	16	75	8
LR2AL040-100	R 2	8	100	4
LR2AL040-100-6	R 2	8	100	6
LR2AL050-100-6	R 2.5	10	100	6
LR2AL060-100-6	R 3	12	100	6
LR2AL080-100	R 4	16	100	8
LR2AL100-100	R 5	20	100	10
LR2AL120-100	R 6	24	100	12
XLR2AL060-6	R 3	12	150	6
XLR2AL080	R 4	16	150	8
XLR2AL100	R 5	20	150	10
XLR2AL120	R 6	24	150	12
XLR2AL160	R 8	32	150	16
XLR2AL200	R 10	40	150	20

d1 (mm)	d1(mm) tolerance
R1	±0.01
R1.5	±0.01
R2	±0.01
R2.5	±0.01
R3	±0.01
R4	±0.01
R5	±0.01
R6	±0.015
R8	±0.02
R10	±0.02

Shank(mm) (h6)	d2(mm) tolerance
Ø 6	0 -0.008
Ø 8	0 -0.008
Ø 10	0 -0.009
Ø 12	0 -0.011
Ø 16	0 -0.011
Ø 20	0 -0.013

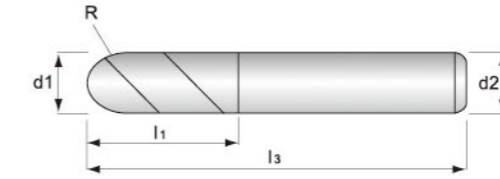

Micro Diameter

Type No. 型號	Diameter R	Flute Length 刃長 l ₁	O. A. L. 全長 l ₃	Shank Dia. 柄徑 d ₂
LR2010F	R 0.5	2	75	4
LR2015F	R 0.75	3	75	4
LR2020F	R 1	4	75	4
LR2030F	R 1.5	6	75	4
LR2040F	R 2	8	75	4
LR2010-75-6	R 0.5	2	75	6
LR2015-75-6	R 0.75	3	75	6
LR2020-75-6	R 1	4	75	6
LR2030-75-6	R 1.5	6	75	6
LR2040-75-6	R 2	8	75	6
LR2050-75-6	R 2.5	10	75	6
LR2060-75-6	R 3	12	75	6
LR2080-75	R 4	16	75	8
LR2040-100	R 2	8	100	4
LR2040-100-6	R 2	8	100	6
LR2050-100-6	R 2.5	10	100	6
LR2060-100-6	R 3	12	100	6
LR2080-100	R 4	16	100	8
LR2100-100	R 5	20	100	10
LR2120-100	R 6	24	100	12
XLR2060-6	R 3	12	150	6
XLR2080	R 4	16	150	8
XLR2100	R 5	20	150	10
XLR2120	R 6	24	150	12
XLR2160	R 8	32	150	16
XLR2200	R 10	40	150	20

High Speed Cutting
& High Hard Cutting

d1 (mm)	d1(mm) tolerance
R1	±0.01
R1.5	±0.01
R2	±0.01
R2.5	±0.01
R3	±0.01
R4	±0.01
R5	±0.01
R6	±0.015
R8	±0.02
R10	±0.02

Shank(mm) (h6)	d2(mm) tolerance
Ø 6	0 -0.008
Ø 8	0 -0.008
Ø 10	0 -0.009
Ø 12	0 -0.011
Ø 16	0 -0.011
Ø 20	0 -0.013

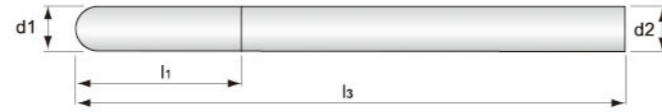

Type No. 型號	Diameter 刃徑 d1	Flute Length 刃長 l1	O. A. L. 全長 l3	Shank Dia. 柄徑 d2
MR4AL010	R 0.5	2	50	4
MR4AL015	R 0.75	3	50	4
MR4AL020	R 1	4	50	4
MR4AL030	R 1.5	6	50	4
MR4AL040	R 2	8	50	4
MR4AL050-6	R 2.5	10	50	6
MR4AL060-6	R 3	12	50	6
MR4AL080	R 4	16	60	8
MR4AL100	R 5	20	75	10
MR4AL120	R 6	24	75	12
MR4AL160	R 8	32	100	16
MR4AL200	R 10	40	100	20

High Speed Cutting
& High Hard Cutting

d1 (mm)	d1(mm) tolerance
R0.5	±0.01
R0.75	±0.01
R1.0	±0.01
R1.5	±0.01
R2.0	±0.01
R2.5	±0.01
R3	±0.01
R4	±0.01
R5	±0.015
R6	±0.015
R8	±0.02
R10	±0.02

Shank(mm) (h6)	d2(mm) tolerance
Ø 4	0 -0.008
Ø 6	0 -0.008
Ø 8	0 -0.009
Ø 10	0 -0.011
Ø 12	0 -0.011
Ø 16	0 -0.011
Ø 20	0 -0.013

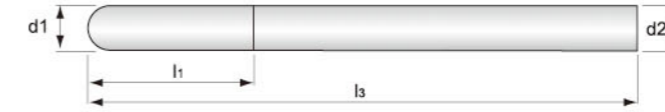

Micro Diameter

Type No. 型號	Diameter 刃徑 d1	Flute Length 刃長 l1	O. A. L. 全長 l3	Shank Dia. 柄徑 d2
MR4010	R 0.5	2	50	4
MR4015	R 0.75	3	50	4
MR4020	R 1	4	50	4
MR4030	R 1.5	6	50	4
MR4040	R 2	8	50	4
MR4050-6	R 2.5	10	50	6
MR4060-6	R 3	12	50	6
MR4080	R 4	16	60	8
MR4100	R 5	20	75	10
MR4120	R 6	24	75	12
MR4160	R 8	32	100	16
MR4200	R 10	40	100	20



High Speed Cutting
& High Hard Cutting

d1 (mm)	d1(mm) tolerance
R0.5	±0.01
R0.75	±0.01
R1.0	±0.01
R1.5	±0.01
R2.0	±0.01
R2.5	±0.01
R3	±0.01
R4	±0.01
R5	±0.015
R6	±0.015
R8	±0.02
R10	±0.02

Shank(mm) (h6)	d2(mm) tolerance
Ø 4	0 -0.008
Ø 6	0 -0.008
Ø 8	0 -0.009
Ø 10	0 -0.011
Ø 12	0 -0.011
Ø 16	0 -0.011
Ø 20	0 -0.013

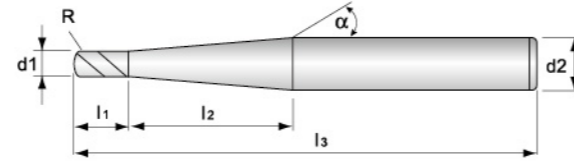

Micro Diameter

Type No. 型號	Diameter 刃徑 d1	Flute Length 刃長 l1	Taper Angle 斜頸 α	Taper Neck 斜頸長 l2	O. A. L. 全長 l3	Shank Dia. 柄徑 d2
MBN2AL0103-6	R 0.5	2	3°	32	75	6
MBN2AL0105-6	R 0.5	2	5°	32	75	6
MBN2AL0203-6	R 1.0	4	3°	27	100	6
MBN2AL0205-6	R 1.0	4	5°	27	100	6
MBN2AL0315-6	R 1.5	6	1.5°	35	100	6
MBN2AL0303-6	R 1.5	6	3°	35	100	6
MBN2AL0415-6	R 2.0	8	1.5°	28	100	6
MBN2AL0403-6	R 2.0	8	3°	28	100	6
MBN2AL0603	R 3.0	12	3°	32	100	8
MBN2AL0605	R 3.0	12	5°	35	100	10
MBN2AL0603	R 3.0	12	3°	32	150	8
MBN2AL0605	R 3.0	12	5°	35	150	10
MBN2AL0803	R 4.0	16	3°	36	100	10
MBN2AL0805	R 4.0	16	5°	39	100	12
MBN2AL0803	R 4.0	16	3°	36	150	10
MBN2AL0805	R 4.0	16	5°	39	150	12
MBN2AL1003	R 5.0	20	3°	40	100	12
MBN2AL1003	R 5.0	20	3°	40	150	12
MBN2AL1205	R 6.0	24	5°	47	100	16
MRN2AL1205	R 6.0	24	5°	47	150	16

High Speed Cutting
& High Hard Cutting

d1 (mm)	d1(mm) tolerance
R1	±0.01
R1.5	±0.01
R2	±0.01
R2.5	±0.01
R3	±0.01
R4	±0.01
R5	±0.01
R6	±0.015

Shank(mm) (h6)	d2(mm) tolerance
Ø 6	0 -0.008
Ø 8	0 -0.008
Ø 10	0 -0.009
Ø 12	0 -0.011
Ø 16	0 -0.011

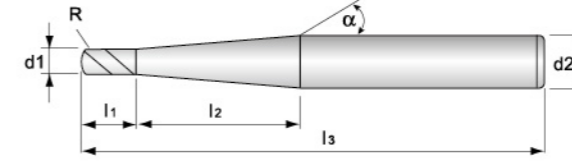

Micro Diameter

Type No. 型號	Diameter 刃徑 d1	Flute Length 刃長 l1	Taper Angle 斜頸 α	Taper Neck 斜頸長 l2	O. A. L. 全長 l3	Shank Dia. 柄徑 d2
MBN20103-6	R 0.5	2	3°	32	75	6
MBN20105-6	R 0.5	2	5°	32	75	6
MBN20203-6	R 1.0	4	3°	27	100	6
MBN20205-6	R 1.0	4	5°	27	100	6
MBN20315-6	R 1.5	6	1.5°	35	100	6
MBN20303-6	R 1.5	6	3°	35	100	6
MBN20415-6	R 2.0	8	1.5°	28	100	6
MBN20403-6	R 2.0	8	3°	28	100	6
MBN20603	R 3.0	12	3°	32	100	8
MBN20605	R 3.0	12	5°	35	100	10
MBN20603	R 3.0	12	3°	32	150	8
MBN20605	R 3.0	12	5°	35	150	10
MBN20803	R 4.0	16	3°	36	100	10
MBN20805	R 4.0	16	5°	39	100	12
MBN20803	R 4.0	16	3°	36	150	10
MBN20805	R 4.0	16	5°	39	150	12
MBN21003	R 5.0	20	3°	40	100	12
MBN21003	R 5.0	20	3°	40	150	12
MBN21205	R 6.0	24	5°	47	100	16
MRN21205	R 6.0	24	5°	47	150	16



High Speed Cutting
& High Hard Cutting

d1 (mm)	d1(mm) tolerance
R1	±0.01
R1.5	±0.01
R2	±0.01
R2.5	±0.01
R3	±0.01
R4	±0.01
R5	±0.01
R6	±0.015

Shank(mm) (h6)	d2(mm) tolerance
Ø 6	0 -0.008
Ø 8	0 -0.008
Ø 10	0 -0.009
Ø 12	0 -0.011
Ø 16	0 -0.011



High Speed Cutting
& High Hard Cutting

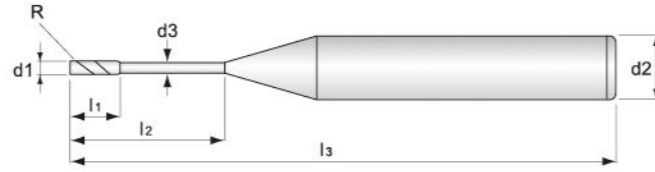

Micro Diameter

Type No. 型號	Diameter 刃徑 d1	Neck Dia. d3	Corner R 圓角 R	Flute Length 刃長 l1	Effective Length 有效長 l2	O. A. L. 全長 l3	Shank Dia. 柄徑 d2
HRMAL1006R	1.0	0.95	0.2	1.5	6	50	4
HRMAL1008R	1.0	0.95	0.2	1.5	8	50	4
HRMAL1010R	1.0	0.95	0.2	1.5	10	50	4
HRMAL1012R	1.0	0.95	0.2	1.5	12	50	4
HRMAL1508R	1.5	1.44	0.2	2.0	8	50	4
HRMAL1510R	1.5	1.44	0.2	2.0	10	50	4
HRMAL1512R	1.5	1.44	0.2	2.0	12	50	4
HRMAL1516R	1.5	1.44	0.2	2.0	16	50	4
HRMAL2008R	2.0	1.92	0.2	3.0	8	50	4
HRMAL2010R	2.0	1.92	0.2	3.0	10	50	4
HRMAL2012R	2.0	1.92	0.2	3.0	12	50	4
HRMAL2016R	2.0	1.92	0.2	3.0	16	50	4
HRMAL2020R	2.0	1.92	0.2	3.0	20	50	4
HRMAL2510R	2.5	2.40	0.2	3.0	10	50	4
HRMAL2512R	2.5	2.40	0.2	3.0	12	50	4
HRMAL2516R	2.5	2.40	0.2	3.0	16	50	4
HRMAL2520R	2.5	2.40	0.2	3.0	20	50	4
HRMAL3010R	3.0	2.90	0.2	4.0	10	50	6
HRMAL3012R	3.0	2.90	0.2	4.0	12	50	6
HRMAL3016R	3.0	2.90	0.2	4.0	16	50	6
HRMAL3020R	3.0	2.90	0.2	4.0	20	60	6
HRMAL3025R	3.0	2.90	0.2	4.0	25	60	6

d1 (mm)	R(mm) tolerance	d1(mm) tolerance
1.0	+0.02 0	0 -0.02
1.5	+0.02 0	0 -0.02
2.0	+0.02 0	0 -0.02
2.5	+0.02 0	0 -0.02
3.0	+0.02 0	0 -0.02

Shank(mm) (h6)	d2(mm) tolerance
Ø 4	0 -0.008
Ø 6	0 -0.008

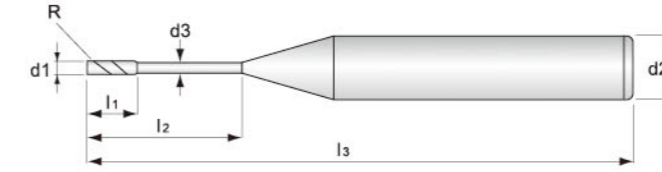

Micro Diameter

Type No. 型號	Diameter 刃徑 d1	Neck Dia. d3	Corner R 圓角 R	Flute Length 刃長 l1	Effective Length 有效長 l2	O. A. L. 全長 l3	Shank Dia. 柄徑 d2
HRM1006R	1.0	0.95	0.2	1.5	6	50	4
HRM1008R	1.0	0.95	0.2	1.5	8	50	4
HRM1010R	1.0	0.95	0.2	1.5	10	50	4
HRM1012R	1.0	0.95	0.2	1.5	12	50	4
HRM1508R	1.5	1.44	0.2	2.0	8	50	4
HRM1510R	1.5	1.44	0.2	2.0	10	50	4
HRM1512R	1.5	1.44	0.2	2.0	12	50	4
HRM1516R	1.5	1.44	0.2	2.0	16	50	4
HRM2008R	2.0	1.92	0.2	3.0	8	50	4
HRM2010R	2.0	1.92	0.2	3.0	10	50	4
HRM2012R	2.0	1.92	0.2	3.0	12	50	4
HRM2016R	2.0	1.92	0.2	3.0	16	50	4
HRM2020R	2.0	1.92	0.2	3.0	20	50	4
HRM2510R	2.5	2.40	0.2	3.0	10	50	4
HRM2512R	2.5	2.40	0.2	3.0	12	50	4
HRM2516R	2.5	2.40	0.2	3.0	16	50	4
HRM2520R	2.5	2.40	0.2	3.0	20	50	4
HRM3010R	3.0	2.90	0.2	4.0	10	50	6
HRM3012R	3.0	2.90	0.2	4.0	12	50	6
HRM3016R	3.0	2.90	0.2	4.0	16	50	6
HRM3020R	3.0	2.90	0.2	4.0	20	60	6
HRM3025R	3.0	2.90	0.2	4.0	25	60	6

High Speed Cutting
& High Hard Cutting



d1 (mm)	R(mm) tolerance	d1(mm) tolerance
1.0	+0.02 0	0 -0.02
1.5	+0.02 0	0 -0.02
2.0	+0.02 0	0 -0.02
2.5	+0.02 0	0 -0.02
3.0	+0.02 0	0 -0.02

Shank(mm) (h6)	d2(mm) tolerance
Ø 4	0 -0.008
Ø 6	0 -0.008



High Speed Cutting
& High Hard Cutting

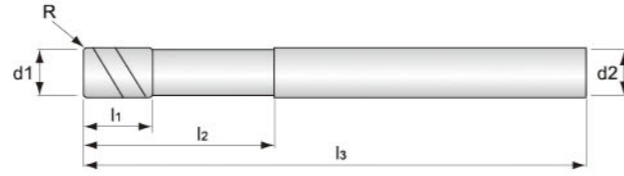

Micro Diameter

Type No. 型號	Diameter 刃徑 d1	Corner R 圓角 R	Flute Length 刃長 l1	Effective Length 有效長 l2	O. A. L. 全長 l3	Shank Dia. 柄徑 d2
SEHRAL0305	3	0.5	1.2	8	50	4
SEHRAL0405	4	0.5	1.6	11	50	4
SEHRAL0410	4	1.0	1.6	11	50	4
SEHRAL0505	5	0.5	2	13	50	6
SEHRAL0510	5	1.0	2	13	50	6
SEHRAL0605	6	0.5	2.5	15	50	6
SEHRAL0610	6	1.0	2.5	15	50	6
SEHRAL0615	6	1.5	2.5	15	50	6
SEHRAL0805	8	0.5	3.5	20	60	8
SEHRAL0810	8	1.0	3.5	20	60	8
SEHRAL0815	8	1.5	3.5	20	60	8
SEHRAL0820	8	2.0	3.5	20	60	8
SEHRAL1005	10	0.5	4	25	75	10
SEHRAL1010	10	1.0	4	25	75	10
SEHRAL1015	10	1.5	4	25	75	10
SEHRAL1020	10	2.0	4	25	75	10
SEHRAL1205	12	0.5	5	25	75	12
SEHRAL1210	12	1.0	5	25	75	12
SEHRAL1215	12	1.5	5	25	75	12
SEHRAL1220	12	2.0	5	25	75	12
SEHRAL1230	12	3.0	5	25	75	12

New

d1 (mm)	R(mm) tolerance	d1(mm) tolerance
4.0	+0.02 0	0 -0.02
6.0	+0.02 0	-0.005 -0.025
8.0	+0.02 0	-0.01 -0.025
10.0	+0.025 0	-0.01 -0.03
12.0	+0.025 0	-0.01 -0.035

Shank(mm) (h6)	d2(mm) tolerance
Ø 6	0 -0.008
Ø 8	0 -0.008
Ø 10	0 -0.009
Ø 12	0 -0.011

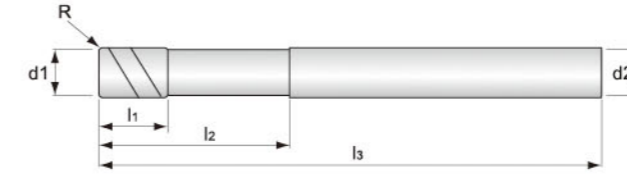

Micro Diameter

Type No. 型號	Diameter 刃徑 d1	Corner R 圓角 R	Flute Length 刃長 l1	Effective Length 有效長 l2	O. A. L. 全長 l3	Shank Dia. 柄徑 d2
SEHR0305	3	0.5	1.2	8	50	4
SEHR0405	4	0.5	1.6	11	50	4
SEHR0410	4	1.0	1.6	11	50	4
SEHR0505	5	0.5	2	13	50	6
SEHR0510	5	1.0	2	13	50	6
SEHR0605	6	0.5	2.5	15	50	6
SEHR0610	6	1.0	2.5	15	50	6
SEHR0615	6	1.5	2.5	15	50	6
SEHR0805	8	0.5	3.5	20	60	8
SEHR0810	8	1.0	3.5	20	60	8
SEHR0815	8	1.5	3.5	20	60	8
SEHR0820	8	2.0	3.5	20	60	8
SEHR1005	10	0.5	4	25	75	10
SEHR1010	10	1.0	4	25	75	10
SEHR1015	10	1.5	4	25	75	10
SEHR1020	10	2.0	4	25	75	10
SEHR1205	12	0.5	5	25	75	12
SEHR1210	12	1.0	5	25	75	12
SEHR1215	12	1.5	5	25	75	12
SEHR1220	12	2.0	5	25	75	12
SEHR1230	12	3.0	5	25	75	12

New



High Speed Cutting
& High Hard Cutting

d1 (mm)	R(mm) tolerance	d1(mm) tolerance
4.0	+0.02 0	0 -0.02
6.0	+0.02 0	-0.005 -0.025
8.0	+0.02 0	-0.01 -0.025
10.0	+0.025 0	-0.01 -0.03
12.0	+0.025 0	-0.01 -0.035

Shank(mm) (h6)	d2(mm) tolerance
Ø 6	0 -0.008
Ø 8	0 -0.008
Ø 10	0 -0.009
Ø 12	0 -0.011

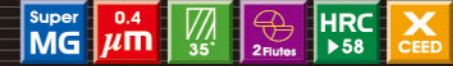
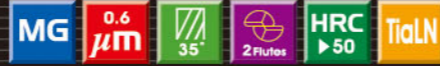

High Speed Cutting
& High Hard Cutting

d1 (mm)	R(mm) tolerance	d1 (mm) tolerance
4.0	+0.02 0	0 -0.02
6.0	+0.02 0	-0.005 -0.025
8.0	+0.02 0	-0.01 -0.025
10.0	+0.025 0	-0.01 -0.03
12.0	+0.025 0	-0.01 -0.035
16.0	+0.03 0	-0.01 -0.04

Shank(mm) (h6)	d2(mm) tolerance
Ø 6	0 -0.008
Ø 8	0 -0.008
Ø 10	0 -0.009
Ø 12	0 -0.011
Ø 16	0 -0.011

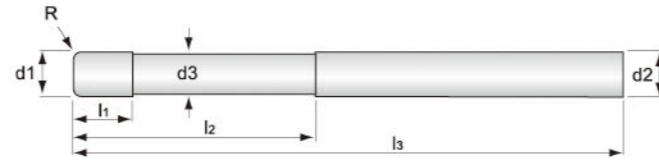

Micro Diameter

Type No. 型號	Diameter 刃徑 d1	Neck Dia. d3	Corner R 圓角 R	Flute Length 刃長 l1	Effective Length 有效長 l2	O. A. L. 全長 l3	Shank Dia. 柄徑 d2
HSERAL0402R	4.0	3.90	0.2	6	12	50	6
HSERAL0405R	4.0	3.90	0.5	6	12	50	6
HSERAL0602R	6.0	5.80	0.2	8	18	50	6
HSERAL0605R	6.0	5.80	0.5	8	18	50	6
HSERAL0610R	6.0	5.80	1.0	8	18	50	6
HSERAL0802R	8.0	7.70	0.2	10	24	60	8
HSERAL0805R	8.0	7.70	0.5	10	24	60	8
HSERAL0810R	8.0	7.70	1.0	10	24	60	8
HSERAL1003R	10.0	9.60	0.3	12	30	75	10
HSERAL1005R	10.0	9.60	0.5	12	30	75	10
HSERAL1010R	10.0	9.60	1.0	12	30	75	10
HSERAL1020R	10.0	9.60	2.0	12	30	75	10
HSERAL1210R	12.0	11.5	1.0	15	36	75	12
HSERAL1220R	12.0	11.5	2.0	15	36	75	12
HSERAL1605R	16.0	15.4	0.5	24	40	100	16
HSERAL1610R	16.0	15.4	1.0	24	40	100	16

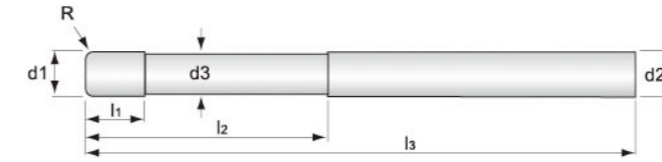

Micro Diameter

Type No. 型號	Diameter 刃徑 d1	Neck Dia. d3	Corner R 圓角 R	Flute Length 刃長 l1	Effective Length 有效長 l2	O. A. L. 全長 l3	Shank Dia. 柄徑 d2
HSER0402R	4.0	3.90	0.2	6	12	50	6
HSER0405R	4.0	3.90	0.5	6	12	50	6
HSER0602R	6.0	5.80	0.2	8	18	50	6
HSER0605R	6.0	5.80	0.5	8	18	50	6
HSER0610R	6.0	5.80	1.0	8	18	50	6
HSER0802R	8.0	7.70	0.2	10	24	60	8
HSER0805R	8.0	7.70	0.5	10	24	60	8
HSER0810R	8.0	7.70	1.0	10	24	60	8
HSER1003R	10.0	9.60	0.3	12	30	75	10
HSER1005R	10.0	9.60	0.5	12	30	75	10
HSER1010R	10.0	9.60	1.0	12	30	75	10
HSER1020R	10.0	9.60	2.0	12	30	75	10
HSER1210R	12.0	11.5	1.0	15	36	75	12
HSER1220R	12.0	11.5	2.0	15	36	75	12
HSER1605R	16.0	15.4	0.5	24	40	100	16
HSER1610R	16.0	15.4	1.0	24	40	100	16



High Speed Cutting
& High Hard Cutting

d1 (mm)	R(mm) tolerance	d1 (mm) tolerance
4.0	+0.02 0	0 -0.02
6.0	+0.02 0	-0.005 -0.025
8.0	+0.02 0	-0.01 -0.025
10.0	+0.025 0	-0.01 -0.03
12.0	+0.025 0	-0.01 -0.035
16.0	+0.03 0	-0.01 -0.04

Shank(mm) (h6)	d2(mm) tolerance
Ø 6	0 -0.008
Ø 8	0 -0.008
Ø 10	0 -0.009
Ø 12	0 -0.011
Ø 16	0 -0.011



High Speed Cutting
& High Hard Cutting

d1 (mm)	R(mm) tolerance	d1(mm) tolerance
1.0	+0.02 0	0 -0.02
1.5	+0.02 0	0 -0.02
2.0	+0.02 0	0 -0.02
2.5	+0.02 0	0 -0.02
3.0	+0.02 0	0 -0.02
4.0	+0.02 0	0 -0.02
5.0	+0.02 0	0 -0.02
6.0	+0.02 0	-0.005 -0.025
8.0	+0.02 0	-0.01 -0.025
10.0	+0.02 0	-0.01 -0.03
12.0	+0.02 0	-0.01 -0.025

Shank(mm) (h6)	d2(mm) tolerance
Ø 4	0 -0.008
Ø 6	0 -0.008
Ø 8	0 -0.008
Ø 10	0 -0.009
Ø 12	0 -0.011

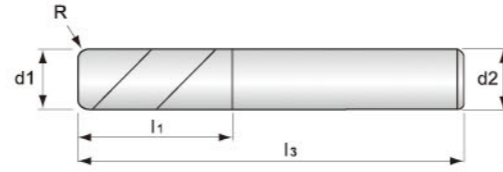

Micro Diameter

Type No. 型號	Diameter 刃徑 d1	Corner R 圓角 R	Flute Length 刃長 l1	O. A. L. 全長 l3	Shank Dia. 柄徑 d2
2RMAL0102R	1.0	R 0.2	2.5	50	4
2RMAL01502R	1.5	R 0.2	4	50	4
2RMAL01505R	1.5	R 0.5	4	50	4
2RMAL0202R	2.0	R 0.2	5	50	4
2RMAL0205R	2.0	R 0.5	5	50	4
2RMAL02502R	2.5	R 0.2	6	50	4
2RMAL02505R	2.5	R 0.5	6	50	4
2RMAL0302R	3.0	R 0.2	8	50	4
2RMAL0305R	3.0	R 0.5	8	50	4
2RMAL0310R	3.0	R 1.0	8	50	4
2RMAL0402R	4.0	R 0.2	10	50	4
2RMAL0405R	4.0	R 0.5	10	50	4
2RMAL0410R	4.0	R 1.0	10	50	4
2RMAL0505R	5.0	R 0.5	12	50	6
2RMAL0510R	5.0	R 1.0	12	50	6
2RMAL0602R	6.0	R 0.2	15	50	6
2RMAL0605R	6.0	R 0.5	15	50	6
2RMAL0610R	6.0	R 1.0	15	50	6
2RMAL0615R	6.0	R 1.5	15	50	6
2RMAL0620R	6.0	R 2.0	15	50	6
2RMAL0805R	8.0	R 0.5	20	60	8
2RMAL0810R	8.0	R 1.0	20	60	8
2RMAL0815R	8.0	R 1.5	20	60	8
2RMAL0820R	8.0	R 2.0	20	60	8
2RMAL1005R	10.0	R 0.5	25	75	10
2RMAL1010R	10.0	R 1.0	25	75	10
2RMAL1015R	10.0	R 1.5	25	75	10
2RMAL1020R	10.0	R 2.0	25	75	10
2RMAL1025R	10.0	R 2.5	25	75	10
2RMAL1030R	10.0	R 3.0	25	75	10
2RMAL1205R	12.0	R 0.5	30	75	12
2RMAL1210R	12.0	R 1.0	30	75	12
2RMAL1215R	12.0	R 1.5	30	75	12
2RMAL1220R	12.0	R 2.0	30	75	12
2RMAL1225R	12.0	R 2.5	30	75	12
2RMAL1230R	12.0	R 3.0	30	75	12

Micro Diameter

Type No. 型號	Diameter 刃徑 d1	Corner R 圓角 R	Flute Length 刃長 l1	O. A. L. 全長 l3	Shank Dia. 柄徑 d2
2RM0102R	1.0	R 0.2	2.5	50	4
2RM01502R	1.5	R 0.2	4	50	4
2RM01505R	1.5	R 0.5	4	50	4
2RM0202R	2.0	R 0.2	5	50	4
2RM0205R	2.0	R 0.5	5	50	4
2RM02502R	2.5	R 0.2	6	50	4
2RM02505R	2.5	R 0.5	6	50	4
2RM0302R	3.0	R 0.2	8	50	4
2RM0305R	3.0	R 0.5	8	50	4
2RM0310R	3.0	R 1.0	8	50	4
2RM0402R	4.0	R 0.2	10	50	4
2RM0405R	4.0	R 0.5	10	50	4
2RM0410R	4.0	R 1.0	10	50	4
2RM0505R	5.0	R 0.5	12	50	6
2RM0510R	5.0	R 1.0	12	50	6
2RM0602R	6.0	R 0.2	15	50	6
2RM0605R	6.0	R 0.5	15	50	6
2RM0610R	6.0	R 1.0	15	50	6
2RM0615R	6.0	R 1.5	15	50	6
2RM0620R	6.0	R 2.0	15	50	6
2RM0805R	8.0	R 0.5	20	60	8
2RM0810R	8.0	R 1.0	20	60	8
2RM0815R	8.0	R 1.5	20	60	8
2RM0820R	8.0	R 2.0	20	60	8
2RM1005R	10.0	R 0.5	25	75	10
2RM1010R	10.0	R 1.0	25	75	10
2RM1015R	10.0	R 1.5	25	75	10
2RM1020R	10.0	R 2.0	25	75	10
2RM1025R	10.0	R 2.5	25	75	10
2RM1030R	10.0	R 3.0	25	75	10
2RM1205R	12.0	R 0.5	30	75	12
2RM1210R	12.0	R 1.0	30	75	12
2RM1215R	12.0	R 1.5	30	75	12
2RM1220R	12.0	R 2.0	30	75	12
2RM1225R	12.0	R 2.5	30	75	12
2RM1230R	12.0	R 3.0	30	75	12

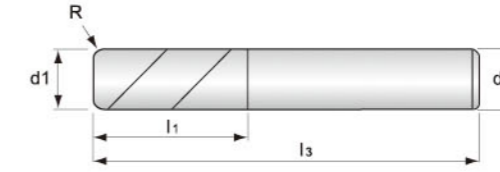

High Speed Cutting
& High Hard Cutting

d1 (mm)	R(mm) tolerance	d1(mm) tolerance
1.0	+0.02 0	0 -0.02
1.5	+0.02 0	0 -0.02
2.0	+0.02 0	0 -0.02
2.5	+0.02 0	0 -0.02
3.0	+0.02 0	0 -0.02
4.0	+0.02 0	0 -0.02
5.0	+0.02 0	0 -0.02
6.0	+0.02 0	-0.005 -0.025
8.0	+0.02 0	-0.01 -0.025
10.0	+0.02 0	-0.01 -0.03
12.0	+0.02 0	-0.01 -0.025

Shank(mm) (h6)	d2(mm) tolerance
Ø 4	0 -0.008
Ø 6	0 -0.008
Ø 8	0 -0.008
Ø 10	0 -0.009
Ø 12	0 -0.011



High Speed Cutting
& High Hard Cutting

d1 (mm)	R(mm) tolerance	d1(mm) tolerance
1.0	+0.02 0	0 -0.02
1.5	+0.02 0	0 -0.02
2.0	+0.02 0	0 -0.02
2.5	+0.02 0	0 -0.02
3.0	+0.02 0	0 -0.02
4.0	+0.02 0	0 -0.02
5.0	+0.02 0	0 -0.02
6.0	+0.02 0	-0.005 -0.025
8.0	+0.02 0	-0.01 -0.025
10.0	+0.02 0	-0.01 -0.03
12.0	+0.02 0	-0.01 -0.025

Shank(mm) (h6)	d2(mm) tolerance
Ø 4	0 -0.008
Ø 6	0 -0.008
Ø 8	0 -0.008
Ø 10	0 -0.009
Ø 12	0 -0.011

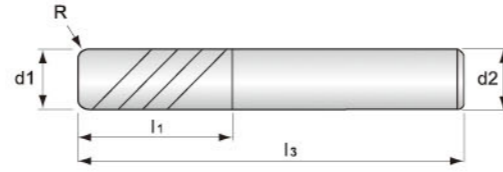

Micro Diameter

Type No. 型號	Diameter 刃徑 d1	Corner R 圓角 R	Flute Length 刃長 l1	O. A. L. 全長 l3	Shank Dia. 柄徑 d2
4RMAL0102R	1.0	R 0.2	2.5	50	4
4RMAL01502R	1.5	R 0.2	4	50	4
4RMAL01505R	1.5	R 0.5	4	50	4
4RMAL0202R	2.0	R 0.2	5	50	4
4RMAL0205R	2.0	R 0.5	5	50	4
4RMAL02502R	2.5	R 0.2	6	50	4
4RMAL02505R	2.5	R 0.5	6	50	4
4RMAL0302R	3.0	R 0.2	8	50	4
4RMAL0305R	3.0	R 0.5	8	50	4
4RMAL0310R	3.0	R 1.0	8	50	4
4RMAL0402R	4.0	R 0.2	10	50	4
4RMAL0405R	4.0	R 0.5	10	50	4
4RMAL0410R	4.0	R 1.0	10	50	4
4RMAL0505R	5.0	R 0.5	12	50	6
4RMAL0510R	5.0	R 1.0	12	50	6
4RMAL0602R	6.0	R 0.2	15	50	6
4RMAL0605R	6.0	R 0.5	15	50	6
4RMAL0610R	6.0	R 1.0	15	50	6
4RMAL0615R	6.0	R 1.5	15	50	6
4RMAL0620R	6.0	R 2.0	15	50	6
4RMAL0805R	8.0	R 0.5	20	60	8
4RMAL0810R	8.0	R 1.0	20	60	8
4RMAL0815R	8.0	R 1.5	20	60	8
4RMAL0820R	8.0	R 2.0	20	60	8
4RMAL1005R	10.0	R 0.5	25	75	10
4RMAL1010R	10.0	R 1.0	25	75	10
4RMAL1015R	10.0	R 1.5	25	75	10
4RMAL1020R	10.0	R 2.0	25	75	10
4RMAL1025R	10.0	R 2.5	25	75	10
4RMAL1030R	10.0	R 3.0	25	75	10
4RMAL1205R	12.0	R 0.5	30	75	12
4RMAL1210R	12.0	R 1.0	30	75	12
4RMAL1215R	12.0	R 1.5	30	75	12
4RMAL1220R	12.0	R 2.0	30	75	12
4RMAL1225R	12.0	R 2.5	30	75	12
4RMAL1230R	12.0	R 3.0	30	75	12

Micro Diameter

Type No. 型號	Diameter 刃徑 d1	Corner R 圓角 R	Flute Length 刃長 l1	O. A. L. 全長 l3	Shank Dia. 柄徑 d2
4RM0102R	1.0	R 0.2	2.5	50	4
4RM01502R	1.5	R 0.2	4	50	4
4RM01505R	1.5	R 0.5	4	50	4
4RM0202R	2.0	R 0.2	5	50	4
4RM0205R	2.0	R 0.5	5	50	4
4RM02502R	2.5	R 0.2	6	50	4
4RM02505R	2.5	R 0.5	6	50	4
4RM0302R	3.0	R 0.2	8	50	4
4RM0305R	3.0	R 0.5	8	50	4
4RM0310R	3.0	R 1.0	8	50	4
4RM0402R	4.0	R 0.2	10	50	4
4RM0405R	4.0	R 0.5	10	50	4
4RM0410R	4.0	R 1.0	10	50	4
4RM0505R	5.0	R 0.5	12	50	6
4RM0510R	5.0	R 1.0	12	50	6
4RM0602R	6.0	R 0.2	15	50	6
4RM0605R	6.0	R 0.5	15	50	6
4RM0610R	6.0	R 1.0	15	50	6
4RM0615R	6.0	R 1.5	15	50	6
4RM0620R	6.0	R 2.0	15	50	6
4RM0805R	8.0	R 0.5	20	60	8
4RM0810R	8.0	R 1.0	20	60	8
4RM0815R	8.0	R 1.5	20	60	8
4RM0820R	8.0	R 2.0	20	60	8
4RM1005R	10.0	R 0.5	25	75	10
4RM1010R	10.0	R 1.0	25	75	10
4RM1015R	10.0	R 1.5	25	75	10
4RM1020R	10.0	R 2.0	25	75	10
4RM1025R	10.0	R 2.5	25	75	10
4RM1030R	10.0	R 3.0	25	75	10
4RM1205R	12.0	R 0.5	30	75	12
4RM1210R	12.0	R 1.0	30	75	12
4RM1215R	12.0	R 1.5	30	75	12
4RM1220R	12.0	R 2.0	30	75	12
4RM1225R	12.0	R 2.5	30	75	12
4RM1230R	12.0	R 3.0	30	75	12

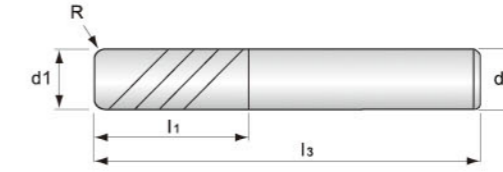

High Speed Cutting
& High Hard Cutting

d1 (mm)	R(mm) tolerance	d1(mm) tolerance
1.0	+0.02 0	0 -0.02
1.5	+0.02 0	0 -0.02
2.0	+0.02 0	0 -0.02
2.5	+0.02 0	0 -0.02
3.0	+0.02 0	0 -0.02
4.0	+0.02 0	0 -0.02
5.0	+0.02 0	0 -0.02
6.0	+0.02 0	-0.005 -0.025
8.0	+0.02 0	-0.01 -0.025
10.0	+0.02 0	-0.01 -0.03
12.0	+0.02 0	-0.01 -0.025

Shank(mm) (h6)	d2(mm) tolerance
Ø 4	0 -0.008
Ø 6	0 -0.008
Ø 8	0 -0.008
Ø 10	0 -0.009
Ø 12	0 -0.011

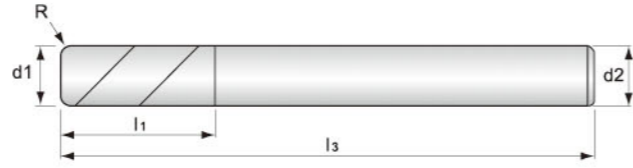
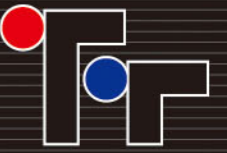

Micro Diameter

Type No. 型號	Diameter 刃徑 d1	Corner R 圓角 R	Flute Length 刃長 l1	O. A. L. 全長 l3	Shank Dia. 柄徑 d2
2LRMAL0302R	3.0	R 0.2	8	75	4
2LRMAL0305R	3.0	R 0.5	8	75	4
2LRMAL0310R	3.0	R 1.0	8	75	4
2LRMAL0402R	4.0	R 0.2	10	75	4
2LRMAL0405R	4.0	R 0.5	10	75	4
2LRMAL0410R	4.0	R 1.0	10	75	4
2LRMAL0505R	5.0	R 0.5	12	100	6
2LRMAL0510R	5.0	R 1.0	12	100	6
2LRMAL0602R	6.0	R 0.2	15	100	6
2LRMAL0605R	6.0	R 0.5	15	100	6
2LRMAL0610R	6.0	R 1.0	15	100	6
2LRMAL0615R	6.0	R 1.5	15	100	6
2LRMAL0620R	6.0	R 2.0	15	100	6
2LRMAL0805R	8.0	R 0.5	20	100	8
2LRMAL0810R	8.0	R 1.0	20	100	8
2LRMAL0815R	8.0	R 1.5	20	100	8
2LRMAL0820R	8.0	R 2.0	20	100	8
2LRMAL1005R	10.0	R 0.5	25	100	10
2LRMAL1010R	10.0	R 1.0	25	100	10
2LRMAL1015R	10.0	R 1.5	25	100	10
2LRMAL1020R	10.0	R 2.0	25	100	10
2LRMAL1030R	10.0	R 3.0	25	100	10
2LRMAL1205R	12.0	R 0.5	30	100	12
2LRMAL1210R	12.0	R 1.0	30	100	12
2LRMAL1215R	12.0	R 1.5	30	100	12
2LRMAL1220R	12.0	R 2.0	30	100	12
2LRMAL1230R	12.0	R 3.0	30	100	12

High Speed Cutting
& High Hard Cutting

d1 (mm)	d1(mm) tolerance
6.0	-0.01 -0.025
8.0	-0.01 -0.025
10.0	-0.01 -0.03
12.0	-0.01 -0.035

Shank(mm) (h6)	d2(mm) tolerance
Ø 6	0 -0.008
Ø 8	0 -0.008
Ø 10	0 -0.008
Ø 12	0 -0.009

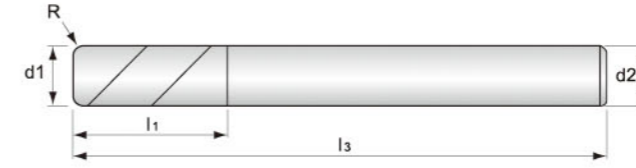

Micro Diameter

Type No. 型號	Diameter 刃徑 d1	Corner R 圓角 R	Flute Length 刃長 l1	O. A. L. 全長 l3	Shank Dia. 柄徑 d2
2LRM0302R	3.0	R 0.2	8	75	4
2LRM0305R	3.0	R 0.5	8	75	4
2LRM0310R	3.0	R 1.0	8	75	4
2LRM0402R	4.0	R 0.2	10	75	4
2LRM0405R	4.0	R 0.5	10	75	4
2LRM0410R	4.0	R 1.0	10	75	4
2LRM0505R	5.0	R 0.5	12	100	6
2LRM0510R	5.0	R 1.0	12	100	6
2LRM0602R	6.0	R 0.2	15	100	6
2LRM0605R	6.0	R 0.5	15	100	6
2LRM0610R	6.0	R 1.0	15	100	6
2LRM0615R	6.0	R 1.5	15	100	6
2LRM0620R	6.0	R 2.0	15	100	6
2LRM0805R	8.0	R 0.5	20	100	8
2LRM0810R	8.0	R 1.0	20	100	8
2LRM0815R	8.0	R 1.5	20	100	8
2LRM0820R	8.0	R 2.0	20	100	8
2LRM1005R	10.0	R 0.5	25	100	10
2LRM1010R	10.0	R 1.0	25	100	10
2LRM1015R	10.0	R 1.5	25	100	10
2LRM1020R	10.0	R 2.0	25	100	10
2LRM1030R	10.0	R 3.0	25	100	10
2LRM1205R	12.0	R 0.5	30	100	12
2LRM1210R	12.0	R 1.0	30	100	12
2LRM1215R	12.0	R 1.5	30	100	12
2LRM1220R	12.0	R 2.0	30	100	12
2LRM1230R	12.0	R 3.0	30	100	12



High Speed Cutting
& High Hard Cutting

d1 (mm)	d1(mm) tolerance
6.0	-0.01 -0.025
8.0	-0.01 -0.025
10.0	-0.01 -0.03
12.0	-0.01 -0.035

Shank(mm) (h6)	d2(mm) tolerance
Ø 6	0 -0.008
Ø 8	0 -0.008
Ø 10	0 -0.008
Ø 12	0 -0.009

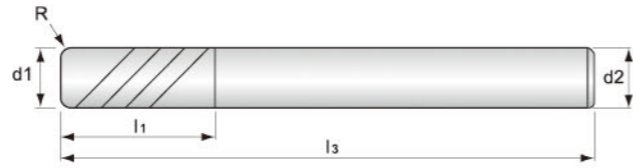

Micro Diameter

Type No. 型號	Diameter 刃徑 d1	Corner R 圓角 R	Flute Length 刃長 l1	O. A. L. 全長 l3	Shank Dia. 柄徑 d2
4LRMAL0302R	3.0	R 0.2	8	75	4
4LRMAL0305R	3.0	R 0.5	8	75	4
4LRMAL0310R	3.0	R 1.0	8	75	4
4LRMAL0402R	4.0	R 0.2	10	75	4
4LRMAL0405R	4.0	R 0.5	10	75	4
4LRMAL0410R	4.0	R 1.0	10	75	4
4LRMAL0505R	5.0	R 0.5	12	100	6
4LRMAL0510R	5.0	R 1.0	12	100	6
4LRMAL0602R	6.0	R 0.2	15	100	6
4LRMAL0605R	6.0	R 0.5	15	100	6
4LRMAL0610R	6.0	R 1.0	15	100	6
4LRMAL0615R	6.0	R 1.5	15	100	6
4LRMAL0620R	6.0	R 2.0	15	100	6
4LRMAL0805R	8.0	R 0.5	20	100	8
4LRMAL0810R	8.0	R 1.0	20	100	8
4LRMAL0815R	8.0	R 1.5	20	100	8
4LRMAL0820R	8.0	R 2.0	20	100	8
4LRMAL1005R	10.0	R 0.5	25	100	10
4LRMAL1010R	10.0	R 1.0	25	100	10
4LRMAL1015R	10.0	R 1.5	25	100	10
4LRMAL1020R	10.0	R 2.0	25	100	10
4LRMAL1030R	10.0	R 3.0	25	100	10
4LRMAL1205R	12.0	R 0.5	30	100	12
4LRMAL1210R	12.0	R 1.0	30	100	12
4LRMAL1215R	12.0	R 1.5	30	100	12
4LRMAL1220R	12.0	R 2.0	30	100	12
4LRMAL1230R	12.0	R 3.0	30	100	12

High Speed Cutting
& High Hard Cutting

d1 (mm)	R(mm) tolerance	d1(mm) tolerance
4.0	+0.02 0	0 -0.02
6.0	+0.02 0	-0.005 -0.025
8.0	+0.03 0	-0.01 -0.025
10.0	+0.03 0	-0.01 -0.03
12.0	+0.03 0	-0.01 -0.035

Shank(mm) (h6)	d2(mm) tolerance
Ø 6	0 -0.008
Ø 8	0 -0.008
Ø 10	0 -0.009
Ø 12	0 -0.011

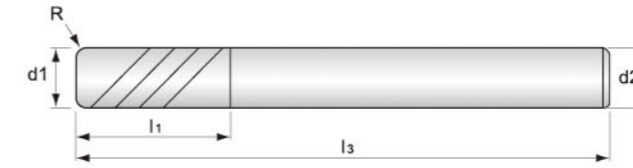

Micro Diameter

Type No. 型號	Diameter 刃徑 d1	Corner R 圓角 R	Flute Length 刃長 l1	O. A. L. 全長 l3	Shank Dia. 柄徑 d2
4LRM0302R	3.0	R 0.2	8	75	4
4LRM0305R	3.0	R 0.5	8	75	4
4LRM0310R	3.0	R 1.0	8	75	4
4LRM0402R	4.0	R 0.2	10	75	4
4LRM0405R	4.0	R 0.5	10	75	4
4LRM0410R	4.0	R 1.0	10	75	4
4LRM0505R	5.0	R 0.5	12	100	6
4LRM0510R	5.0	R 1.0	12	100	6
4LRM0602R	6.0	R 0.2	15	100	6
4LRM0605R	6.0	R 0.5	15	100	6
4LRM0610R	6.0	R 1.0	15	100	6
4LRM0615R	6.0	R 1.5	15	100	6
4LRM0620R	6.0	R 2.0	15	100	6
4LRM0805R	8.0	R 0.5	20	100	8
4LRM0810R	8.0	R 1.0	20	100	8
4LRM0815R	8.0	R 1.5	20	100	8
4LRM0820R	8.0	R 2.0	20	100	8
4LRM1005R	10.0	R 0.5	25	100	10
4LRM1010R	10.0	R 1.0	25	100	10
4LRM1015R	10.0	R 1.5	25	100	10
4LRM1020R	10.0	R 2.0	25	100	10
4LRM1030R	10.0	R 3.0	25	100	10
4LRM1205R	12.0	R 0.5	30	100	12
4LRM1210R	12.0	R 1.0	30	100	12
4LRM1215R	12.0	R 1.5	30	100	12
4LRM1220R	12.0	R 2.0	30	100	12
4LRM1230R	12.0	R 3.0	30	100	12



High Speed Cutting
& High Hard Cutting

d1 (mm)	R(mm) tolerance	d1(mm) tolerance
4.0	+0.02 0	0 -0.02
6.0	+0.02 0	-0.005 -0.025
8.0	+0.03 0	-0.01 -0.025
10.0	+0.03 0	-0.01 -0.03
12.0	+0.03 0	-0.01 -0.035

Shank(mm) (h6)	d2(mm) tolerance
Ø 6	0 -0.008
Ø 8	0 -0.008
Ø 10	0 -0.009
Ø 12	0 -0.011



High Speed Cutting
& High Hard Cutting

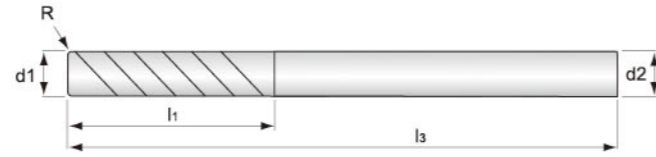

Micro Diameter

Type No. 型號	Diameter 刃徑 d1	Corner R 圓角 R	Flute Length 刃長 l ₁	O. A. L. 全長 l ₃	Shank Dia. 柄徑 d2
H6ORWAL0605R	6.0	R 0.5	16	50	6
H6ORWAL0610R	6.0	R 1.0	16	50	6
H6ORWAL0805R	8.0	R 0.5	20	60	8
H6ORWAL0810R	8.0	R 1.0	20	60	8
H6ORWAL1010R	10.0	R 1.0	25	75	10
H6ORWAL1210R	12.0	R 1.0	30	75	12
H6ORWAL1610R	16.0	R 1.0	40	100	16
H6ORWAL1620R	16.0	R 2.0	40	100	16
H6ORWAL2020R	20.0	R 2.0	45	100	20

d1 (mm)	R(mm) tolerance	d1(mm) tolerance
6.0	+0.02 0	0 -0.025
8.0	+0.02 0	0 -0.025
10.0	+0.02 0	0 -0.03
12.0	+0.03 0	0 -0.03
16.0	+0.03 0	0 -0.04
20.0	+0.03 0	0 -0.04

Shank(mm) (h6)	d2(mm) tolerance
Ø 6	0 -0.008
Ø 8	0 -0.008
Ø 10	0 -0.009
Ø 12	0 -0.011
Ø 16	0 -0.011
Ø 20	0 -0.013

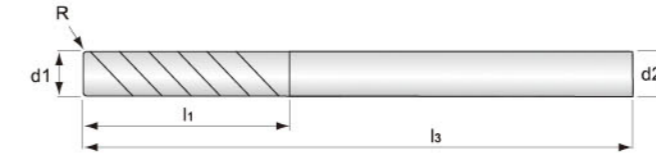

Micro Diameter

Type No. 型號	Diameter 刃徑 d1	Corner R 圓角 R	Flute Length 刃長 l ₁	O. A. L. 全長 l ₃	Shank Dia. 柄徑 d2
H6ORW0605R	6.0	R 0.5	16	50	6
H6ORW0610R	6.0	R 1.0	16	50	6
H6ORW0805R	8.0	R 0.5	20	60	8
H6ORW0810R	8.0	R 1.0	20	60	8
H6ORW1010R	10.0	R 1.0	25	75	10
H6ORW1210R	12.0	R 1.0	30	75	12
H6ORW1610R	16.0	R 1.0	40	100	16
H6ORW1620R	16.0	R 2.0	40	100	16
H6ORW2020R	20.0	R 2.0	45	100	20



High Speed Cutting
& High Hard Cutting

d1 (mm)	R(mm) tolerance	d1(mm) tolerance
6.0	+0.02 0	0 -0.025
8.0	+0.02 0	0 -0.025
10.0	+0.02 0	0 -0.03
12.0	+0.03 0	0 -0.03
16.0	+0.03 0	0 -0.04
20.0	+0.03 0	0 -0.04

Shank(mm) (h6)	d2(mm) tolerance
Ø 6	0 -0.008
Ø 8	0 -0.008
Ø 10	0 -0.009
Ø 12	0 -0.011
Ø 16	0 -0.011
Ø 20	0 -0.013

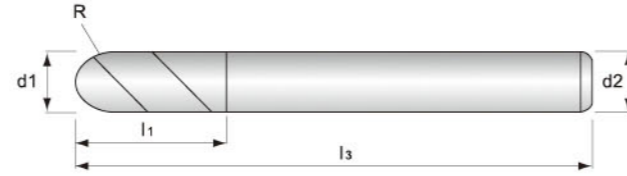
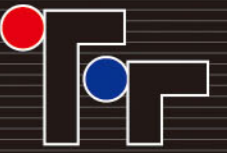

Micro Diameter

Type No. 型號	Diameter 刃徑 d1	Flute Length 刃長 l1	O. A. L. 全長 l3	Shank Dia. 柄徑 d2
UR010	R 0.5	2	50	4
UR015	R 0.75	3	50	4
UR020	R 1.0	4	50	4
UR030	R 1.5	6	50	4
UR040	R 2.0	8	50	4
UR050	R 2.5	10	50	6
UR060	R 3.0	12	50	6
UR080	R 4.0	16	60	8
UR100	R 5.0	20	75	10
UR120	R 6.0	24	75	12
UR160	R 8.0	32	100	16
UR200	R 10.0	32	100	20

High Speed Cutting
& High Hard Cutting

d1 (mm)	d1(mm) tolerance
R1	±0.01
R1.5	±0.01
R2	±0.01
R2.5	±0.01
R3	±0.01
R4	±0.01
R5	±0.01
R6	±0.015
R8	±0.02
R10	±0.02

Shank(mm) (h6)	d2(mm) tolerance
Ø 6	0 -0.008
Ø 8	0 -0.008
Ø 10	0 -0.009
Ø 12	0 -0.011
Ø 16	0 -0.011
Ø 20	0 -0.013

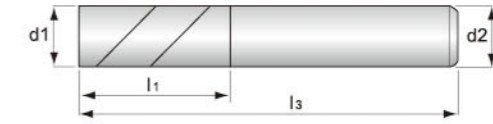

Micro Diameter

Type No. 型號	Diameter 刃徑 d1	Flute Length 刃長 l1	O. A. L. 全長 l3	Shank Dia. 柄徑 d2
155WW010	1.0	2.5	50	4
155WW020	2.0	5	50	4
155WW030	3.0	8	50	4
155WW040	4.0	10	50	4
155WW050	5.0	13	50	6
155WW060	6.0	15	50	6
155WW070	7.0	18	60	8
155WW080	8.0	20	60	8
155WW090	9.0	23	75	10
155WW100	10.0	25	75	10
155WW110	11.0	28	75	12
155WW120	12.0	30	75	12
155WW160	16.0	40	100	16
155WW200	20.0	40	100	20

High Speed Cutting
& High Hard Cutting



極細微粒碳化鎢 3刃立銑刀(鋁合金專用)
Micro Grain Carbide, 3-flute, End Mills (for Aluminum Alloys Processing)

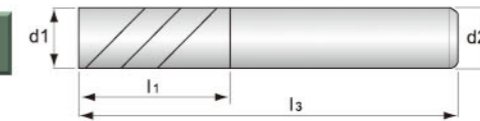

Micro Diameter

Type No. 型號	Diameter 刃徑 d1	Flute Length 刃長 l1	O. A. L. 全長 l3	Shank Dia. 柄徑 d2
155WW030X3T	3.0	8	50	4
155WW040X3T	4.0	10	50	4
155WW050X3T	5.0	13	50	6
155WW060X3T	6.0	15	50	6
155WW080X3T	8.0	20	60	8
155WW100X3T	10.0	25	75	10
155WW120X3T	12.0	30	75	12
155WW160X3T	16.0	40	100	16
155WW200X3T	20.0	40	100	20



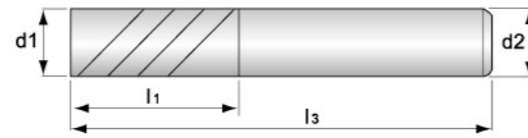

Micro Diameter

Type No. 型號	Diameter 刃徑 d1	Flute Length 刃長 l1	O. A. L. 全長 l3	Shank Dia. 柄徑 d2
L155WW030	3.0	12	75	6
L155WW040	4.0	16	75	6
L155WW050	5.0	20	75	6
L155WW060	6.0	25	75	6
L155WW080	8.0	32	75	8
L155WW080B	8.0	35	100	8
L155WW100	10.0	40	100	10
L155WW120	12.0	45	100	12
L155WW160	16.0	65	150	16
L155WW200	20.0	75	150	20

High Speed Cutting
& High Hard Cutting

極細微粒碳化鎢 長刃 3刃立銑刀(鋁合金專用)
Micro Grain Carbide, Long-flute, 3-flute, End Mills (for Aluminum Alloys Processing)

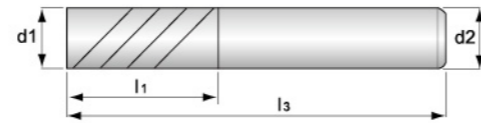

Micro Diameter

Type No. 型號	Diameter 刃徑 d1	Flute Length 刃長 l1	O. A. L. 全長 l3	Shank Dia. 柄徑 d2
L155WW030X3T	3.0	12	75	6
L155WW040X3T	4.0	16	75	6
L155WW050X3T	5.0	20	75	6
L155WW060X3T	6.0	25	75	6
L155WW060X3T	6.0	25	100	6
L155WW080X3T	8.0	32	75	8
L155WW080BX3T	8.0	35	100	8
L155WW100X3T	10.0	40	100	10
L155WW120X3T	12.0	45	100	12
L155WW160X3T	16.0	65	150	16
L155WW200X3T	20.0	75	150	20

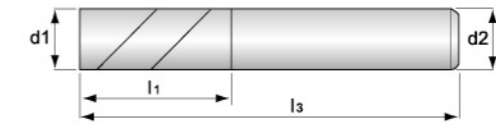

Micro Diameter

Type No. 型號	Diameter 刃徑 d1	Flute Length 刃長 l1	O. A. L. 全長 l3	Shank Dia. 柄徑 d2
145WW040A	4	10	50	4
145WW050A	5	13	50	6
145WW060A	6	15	50	6
145WW080A	8	20	60	8
145WW100A	10	25	75	10
145WW120A	12	30	75	12
145WW160A	16	40	100	16

New

極細微粒碳化鎢 3刃 鏡面立銑刀(鋁用金專用)
Micro Grain Carbide, 3-flute, Smooth Surface End Mills (for Aluminum Alloys Processing)

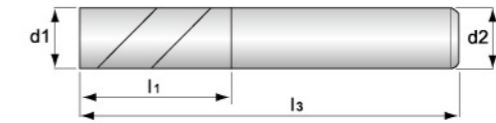

Micro Diameter

Type No. 型號	Diameter 刃徑 d1	Flute Length 刃長 l1	O. A. L. 全長 l3	Shank Dia. 柄徑 d2
145WW040AX3T	4	10	50	4
145WW050AX3T	5	13	50	6
145WW060AX3T	6	15	50	6
145WW080AX3T	8	20	60	8
145WW100AX3T	10	25	75	10
145WW120AX3T	12	30	75	12
145WW160AX3T	16	40	100	16

New

High Speed Cutting
& High Hard Cutting





High Speed Cutting
& High Hard Cutting

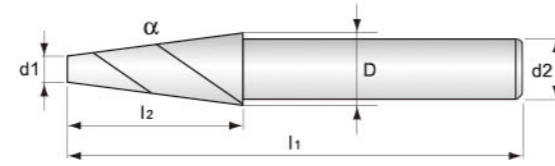

Micro Diameter

Type No. 型號	Diameter 先徑端 d1	Flute Length 刃長 l2	Taper Angle 斜度 α	Large Mill Dia. 粗端徑 D	O. A. L. 全長 l1	Shank Dia. 柄徑 d2
TPM1ø0.5°	1.0	4	0.5°	1.07	50	4
TPM1ø1°	1.0	4	1°	1.14	50	4
TPM1ø1.5°	1.0	4	1.5°	1.21	50	4
TPM1ø2°	1.0	4	2°	1.28	50	4
TPM1ø2.5°	1.0	4	2.5°	1.35	50	4
TPM1ø3°	1.0	4	3°	1.42	50	4
TPM1ø5°	1.0	5	5°	1.7	50	4
TPM1ø7°	1.0	5	7°	1.98	50	4
TPM1ø10°	1.0	5	10°	2.41	50	4
TPM1.5ø0.5°	1.5	5	0.5°	1.59	50	4
TPM1.5ø1°	1.5	5	1°	1.67	50	4
TPM1.5ø1.5°	1.5	5	1.5°	1.76	50	4
TPM1.5ø2°	1.5	5	2°	1.85	50	4
TPM1.5ø2.5°	1.5	5	2.5°	1.93	50	4
TPM1.5ø3°	1.5	5	3°	2.02	50	4
TPM1.5ø5°	1.5	5	5°	2.37	50	4
TPM1.5ø7°	1.5	5	7°	2.73	50	4
TPM1.5ø10°	1.5	5	10°	3.26	50	4
TPM2ø0.5°	2.0	6	0.5°	2.10	50	4
TPM2ø1°	2.0	6	1°	2.21	50	4
TPM2ø1.5°	2.0	6	1.5°	2.31	50	4
TPM2ø2°	2.0	6	2°	2.41	50	4
TPM2ø2.5°	2.0	6	2.5°	2.52	50	4
TPM2ø3°	2.0	6	3°	2.62	50	4
TPM2ø5°	2.0	6	5°	3.05	50	4
TPM2ø7°	2.0	6	7°	3.47	50	4
TPM2ø10°	2.0	6	10°	4.12	50	4
TPM2.5ø0.5°	2.5	8	0.5°	2.64	50	4
TPM2.5ø1°	2.5	8	1°	2.78	50	4
TPM2.5ø1.5°	2.5	8	1.5°	2.91	50	4
TPM2.5ø2°	2.5	8	2°	3.05	50	4
TPM2.5ø2.5°	2.5	8	2.5°	3.20	50	4
TPM2.5ø3°	2.5	8	3°	3.33	50	4
TPM2.5ø5°	2.5	8	5°	3.90	50	4
TPM2.5ø7°	2.5	8	7°	4.46	50	4
TPM2.5ø10°	2.5	8	10°	5.32	50	4
FATPM3ø0.5°	3.0	10	0.5°	3.17	50	4
TPFAM3ø1°	3.0	10	1°	3.35	50	4
TPM3ø1.5°	3.0	10	1.5°	3.52	50	4
TPFAM3ø2°	3.0	10	2°	3.69	50	4
TPM3ø2.5°	3.0	10	2.5°	3.87	50	4
TPM3ø3°	3.0	10	3°	4.05	50	6
TPM3ø5°	3.0	10	5°	4.75	50	6
TPM3ø7°	3.0	10	7°	5.45	50	6
TPM3ø10°	3.0	10	10°	6.53	60	8

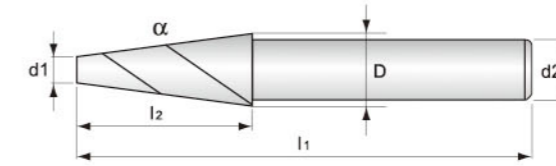

Micro Diameter

Type No. 型號	Diameter 先徑端 d1	Flute Length 刃長 l2	Taper Angle 斜度 α	Large Mill Dia. 粗端徑 D	O. A. L. 全長 l1	Shank Dia. 柄徑 d2
TPM4ø0.5°	4.0	15	0.5°	4.26	50	6
TPM4ø1°	4.0	15	1°	4.52	50	6
TPM4ø1.5°	4.0	15	1.5°	4.79	50	6
TPM4ø2°	4.0	15	2°	5.04	50	6
TPM4ø2.5°	4.0	15	2.5°	5.31	50	6
TPM4ø3°	4.0	15	3°	5.57	50	6
TPM4ø5°	4.0	15	5°	6.62	60	8
TPM4ø7°	4.0	15	7°	7.68	60	8
TPM4ø10°	4.0	15	10°	9.30	75	10
TPM5ø0.5°	5.0	20	0.5°	5.34	50	8
TPM5ø1°	5.0	20	1°	5.70	50	8
TPM5ø1.5°	5.0	20	1.5°	6.04	60	8
TPM5ø2°	5.0	20	2°	6.39	60	8
TPM5ø2.5°	5.0	20	2.5°	6.74	60	8
TPM5ø3°	5.0	20	3°	7.10	60	8
TPM5ø5°	5.0	20	5°	8.50	75	10
TPM5ø7°	5.0	20	7°	9.91	75	10
TPM5ø10°	5.0	20	10°	12.05	75	12
TPM6ø0.5°	6.0	20	0.5°	6.35	60	8
TPM6ø1°	6.0	20	1°	6.70	60	8
TPM6ø1.5°	6.0	20	1.5°	7.05	60	8
TPM6ø2°	6.0	20	2°	7.40	60	8
TPM6ø2.5°	6.0	20	2.5°	7.75	60	8
TPM6ø3°	6.0	20	3°	8.10	75	10
TPM6ø5°	6.0	20	5°	9.50	75	10
TPM6ø7°	6.0	20	7°	10.91	75	12
TPM6ø10°	6.0	20	10°	13.05	75	12
TPM8ø0.5°	8.0	25	0.5°	8.44	75	10
TPM8ø1°	8.0	25	1°	8.87	75	10
TPM8ø1.5°	8.0	25	1.5°	9.31	75	10
TPM8ø2°	8.0	25	2°	9.74	75	10
TPM8ø2.5°	8.0	25	2.5°	10.18	75	12
TPM8ø3°	8.0	25	3°	10.62	75	12
TPM8ø5°	8.0	25	5°	12.37	100	16
TPM8ø7°	8.0	25	7°	14.14	100	16
TPM8ø10°	8.0	25	10°	16.82	100	16
TPM10ø0.5°	10.0	35	0.5°	10.61	100	16
TPM10ø1°	10.0	35	1°	11.22	100	16
TPM10ø1.5°	10.0	35	1.5°	11.83	100	16
TPM10ø2°	10.0	35	2°	12.44	100	16
TPM10ø2.5°	10.0	35	2.5°	13.06	100	16
TPM10ø3°	10.0	35	3°	13.67	100	16
TPM10ø5°	10.0	35	5°	16.12	100	16
TPM10ø7°	10.0	35	7°	18.30	100	16
TPM10ø10°	10.0	35	10°	22.34	100	16



High Speed Cutting
& High Hard Cutting



High Speed Cutting
& High Hard Cutting

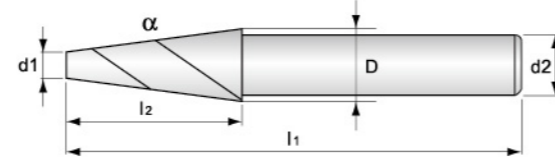

Micro Diameter

Type No. 型號	Diameter 先徑端 d1	Flute Length 刃長 l2	Taper Angle 斜度 α	Large Mill Dia. 粗端徑 D	O. A. L. 全長 l1	Shank Dia. 柄徑 d2
4TPM3ø0.5°	3.0	10	0.5°	3.17	50	4
4TPM3ø1°	3.0	10	1°	3.35	50	4
4TPM3ø1.5°	3.0	10	1.5°	3.52	50	4
4TPM3ø2°	3.0	10	2°	3.07	50	4
4TPM3ø3°	3.0	10	3°	4.05	50	6
4TPM3ø5°	3.0	10	5°	4.75	50	6
4TPM4ø0.5°	4.0	15	0.5°	4.26	50	6
4TPM4ø1°	4.0	15	1°	4.52	50	6
4TPM4ø1.5°	4.0	15	1.5°	4.79	50	6
4TPM4ø2°	4.0	15	2°	5.05	50	6
4TPM4ø3°	4.0	15	3°	5.57	50	6
4TPM4ø5°	4.0	15	5°	6.62	60	8
4TPM5ø0.5°	5.0	20	0.5°	5.35	50	6
4TPM5ø1°	5.0	20	1°	5.70	50	6
4TPM5ø1.5°	5.0	20	1.5°	6.05	60	8
4TPM5ø2°	5.0	20	2°	6.40	60	8
4TPM5ø3°	5.0	20	3°	7.10	60	8
4TPM5ø5°	5.0	20	5°	8.50	75	10
4TPM6ø0.5°	6.0	20	0.5°	6.35	75	8
4TPM6ø1°	6.0	20	1°	6.70	75	8
4TPM6ø1.5°	6.0	20	1.5°	7.05	75	8
4TPM6ø2°	6.0	20	2°	7.40	75	8
4TPM6ø3°	6.0	20	3°	8.10	75	10
4TPM6ø5°	6.0	20	5°	9.50	75	10
4TPM8ø0.5°	8.0	25	0.5°	8.44	75	10
4TPM8ø1°	8.0	25	1°	8.87	75	10
4TPM8ø1.5°	8.0	25	1.5°	9.31	75	10
4TPM8ø2°	8.0	25	2°	9.75	75	10
4TPM8ø3°	8.0	25	3°	10.62	75	16
4TPM8ø5°	8.0	25	5°	12.37	100	16
4TPM10ø0.5°	10.0	35	0.5°	10.61	100	16
4TPM10ø1°	10.0	35	1°	11.22	100	16
4TPM10ø1.5°	10.0	35	1.5°	11.83	100	16
4TPM10ø2°	10.0	35	2°	12.44	100	16
4TPM10ø3°	10.0	35	3°	13.67	100	16
4TPM10ø5°	10.0	35	5°	16.00	100	16

Micro Diameter

Diameter 先徑端 d1	Flute Length 刃長 l2	O. A. L. 全長 l1	Shank Dia. 柄徑 d2
3.0	6	50	3
4.0	8	50	4
4.0	8	75	4
4.0	8	100	4
6.0	12	50	6
6.0	12	75	6
6.0	12	100	6
6.0	12	150	6
8.0	16	60	8
8.0	16	100	8
8.0	16	150	8
8.0	16	200	8
10.0	20	75	10
10.0	20	100	10
10.0	20	150	10
10.0	20	200	10
12.0	24	75	12
12.0	24	100	12
12.0	24	150	12
12.0	24	200	12
16.0	30	100	16
16.0	30	150	16
16.0	30	200	16
20.0	30	100	20
20.0	30	150	20
20.0	30	200	20



High Speed Cutting
& High Hard Cutting



High Speed Cutting & High Hard Cutting

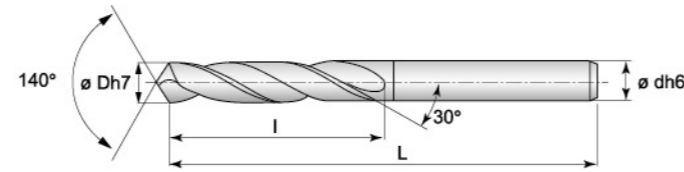

Micro Diameter

Type No. 型號	Flute Length 刃長 l	O. A. L. 全長 L	Shank Dia. 柄徑	Type No. 型號	Flute Length 刃長 l	O. A. L. 全長 L	Shank Dia. 柄徑
M132-020	12	38	2.0	M132-043	24	58	4.3
M132-021	12	38	2.1	M132-044	24	58	4.4
M132-022	13	40	2.2	M132-045	24	58	4.5
M132-023	13	40	2.3	M132-046	24	58	4.6
M132-024	14	43	2.4	M132-047	24	58	4.7
M132-025	14	43	2.5	M132-048	26	62	4.8
M132-026	14	43	2.6	M132-049	26	62	4.9
M132-027	16	46	2.7	M132-050	26	62	5.0
M132-028	16	46	2.8	M132-051	26	62	5.1
M132-029	16	46	2.9	M132-052	26	62	5.2
M132-030	16	46	3.0	M132-053	26	62	5.3
M132-031	18	49	3.1	M132-054	28	66	5.4
M132-032	18	49	3.2	M132-055	28	66	5.5
M132-033	18	49	3.3	M132-056	28	66	5.6
M132-034	20	52	3.4	M132-057	28	66	5.7
M132-035	20	52	3.5	M132-058	28	66	5.8
M132-036	20	52	3.6	M132-059	28	66	5.9
M132-037	20	52	3.7	M132-060	28	66	6.0
M132-038	22	55	3.8	M132-061	31	70	6.1
M132-039	22	55	3.9	M132-062	31	70	6.2
M132-040	22	55	4.0	M132-063	31	70	6.3
M132-041	22	55	4.1	M132-064	31	70	6.4
M132-042	22	55	4.2	M132-065	31	70	6.5

● 最適於鋼材、極難切削材之孔加工

被削材 Working Material	普通鋼・合成鋼 Carbon Steel, Alloy Steel					
	(<HRC30 未滿)		(HRC30~45)		(HRC45~55)	
	80 m/nin		60 m/nin		15 m/nin	
切削速度 Cutting Speed	回轉數 Speed (rpm)	進給 Feed (mm/min)	回轉數 Speed (rpm)	進給 Feed (mm/min)	回轉數 Speed (rpm)	進給 Feed (mm/min)
刃徑 D						
3	8500	1300	6400	770	1600	160
4	6400	1150	4800	670	1200	130
6	4200	880	3200	540	800	100
8	3200	800	2400	480	600	85
10	2500	680	1900	420	480	70
12	2100	610	1600	370	400	65

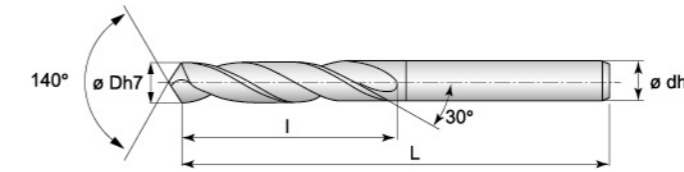

Type No. 型號	Flute Length 刃長 l	O. A. L. 全長 L	Shank Dia. 柄徑	Type No. 型號	Flute Length 刃長 l	O. A. L. 全長 L	Shank Dia. 柄徑
M132-066	31	70	6.6	M132-089	40	84	8.9
M132-067	31	70	6.7	M132-090	40	84	9.0
M132-068	34	74	6.8	M132-091	40	84	9.1
M132-069	34	74	6.9	M132-092	40	84	9.2
M132-070	34	74	7.0	M132-093	40	84	9.3
M132-071	34	74	7.1	M132-094	40	84	9.4
M132-072	34	74	7.2	M132-095	40	84	9.5
M132-073	34	74	7.3	M132-096	40	84	9.6
M132-074	34	74	7.4	M132-097	40	84	9.7
M132-075	34	74	7.5	M132-098	40	84	9.8
M132-076	37	79	7.6	M132-099	40	84	9.9
M132-077	37	79	7.7	M132-100	40	84	10.0
M132-078	37	79	7.8	M132-102	40	84	10.2
M132-079	37	79	7.9	M132-105	43	89	10.5
M132-080	37	79	8.0	M132-110	47	95	11.0
M132-081	37	79	8.1	M132-115	47	95	11.5
M132-082	37	79	8.2	M132-117	47	95	11.7
M132-083	37	79	8.3	M132-118	47	95	11.8
M132-084	37	79	8.4	M132-119	47	95	11.9
M132-085	37	79	8.5	M132-120	51	102	12.0
M132-086	40	84	8.6	M132-125	51	102	12.5
M132-087	40	84	8.7	M132-130	51	102	13.0
M132-088	40	84	8.8				

● 最適於鋼材、極難切削材之孔加工

被削材 Working Material	不鏽鋼 Stainless Steel (SUS302, 304)		球狀黑鉛鑄鐵 Graphite Cast Iron (FCD60,61)	
	20 m/nin		66 m/nin	
	回轉數 Speed (rpm)	進給 Feed (mm/min)	回轉數 Speed (rpm)	進給 Feed (mm/min)
切削速度 Cutting Speed				
刃徑 D				
3	2100	210	7000	1050
4	1600	180	5300	900
6	1050	130	3500	700
8	800	110	2600	600
10	640	100	2000	520
12	540	90	1750	450



High Speed Cutting & High Hard Cutting



High Speed Cutting
& High Hard Cutting

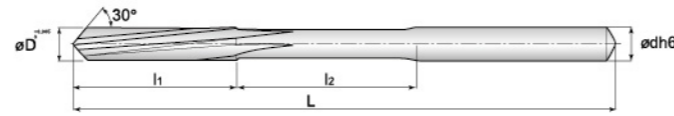

Micro Diameter

Shank Dia. 柄徑	Flute Length 刃長 l ₁	O. A. L. 全長 L	Effec. Length 有效長 l ₂	Flute No. 刃數
2.0	11	49	24	4
2.1	11	49	24	4
2.2	12	53	26	4
2.3	12	53	26	4
2.4	14	57	28	4
2.5	14	57	28	4
2.6	14	57	28	4
2.7	15	61	32	4
2.8	15	61	32	4
2.9	15	61	32	4
3.0	15	61	32	4
3.1	16	65	35	4
3.2	16	65	35	4
3.3	16	65	35	4
3.4	18	70	40	4
3.5	18	70	40	4
3.6	18	70	40	4
3.7	18	70	40	4
3.8	19	75	43	4
3.9	19	75	43	4
4.0	19	75	43	4
4.1	19	75	43	4
4.2	19	75	43	4
4.3	21	80	47	4
4.4	21	80	47	4
4.5	21	80	47	4
4.6	21	80	47	4
4.7	21	80	47	4
4.8	23	86	52	4
4.9	23	86	52	4
5.0	23	86	52	4
5.1	23	86	52	4
5.2	23	86	52	4
5.3	23	86	52	4

刃徑	預留削除量	被削材		鋁合金	
		炭素鋼・高硬度合金鋼 (SKD, SUS)		鋁合金	
		切削速度: 5 - 9 m/min		切削速度: 10 - 20m/min	
		回轉數 (rpm)	進給 (mm/min)	回轉數 (rpm)	進給 (mm/min)
2	0.1 - 0.2	1000	0.1 - 0.2	2800	0.2 - 0.3
4	0.1 - 0.2	500	0.1 - 0.2	1400	0.2 - 0.3
6	0.2 - 0.3	340	0.2 - 0.3	950	0.2 - 0.3
8	0.2 - 0.3	250	0.2 - 0.3	720	0.3 - 0.4
10	0.2 - 0.3	190	0.2 - 0.3	570	0.3 - 0.4
12	0.2 - 0.3	160	0.2 - 0.3	480	0.4 - 0.5

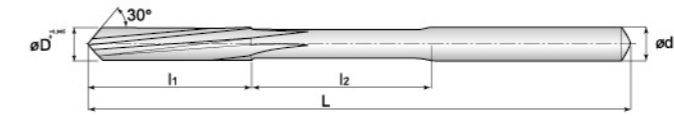

Micro Diameter

Shank Dia. 柄徑	Flute Length 刃長 l ₁	O. A. L. 全長 L	Effec. Length 有效長 l ₂	Flute No. 刃數
5.4	26	93	57	4
5.5	26	93	57	4
5.6	26	93	57	4
5.7	26	93	57	4
5.8	26	93	57	4
5.9	26	93	57	4
6.0	26	93	57	4
6.1	28	101	63	6
6.2	28	101	63	6
6.3	28	101	63	6
6.4	28	101	63	6
6.5	28	101	63	6
6.6	31	110	69	6
6.7	31	110	69	6
6.8	31	110	69	6
6.9	31	110	69	6
7.0	31	110	69	6
7.1	31	110	69	6
7.2	31	110	69	6
7.3	31	110	69	6
7.4	31	110	69	6
7.5	31	110	69	6
7.6	31	110	69	6
7.8	31	110	69	6
7.9	31	110	69	6
8.0	31	110	69	6
8.5	31	110	69	6
9.0	33	110	69	6
9.5	33	110	69	6
10.0	36	110	69	6
11.0	41	142	95	6
12.0	44	151	105	6
13.0	44	151	105	6

鑄鐵 (FC, FCD)	
切削速度: 9 - 12m/min	
回轉數 (rpm)	進給 (mm/min)
1800	0.2 - 0.3
940	0.2 - 0.3
630	0.2 - 0.3
470	0.3 - 0.4
380	0.3 - 0.4
300	0.3 - 0.5

● 螺旋刃
使用超微粒超硬合金
最適於高精度、高效率化

注1: 絞孔加工依使用機械及作業條件而其最佳切削條件亦隨之變動, 因此應適宜調整為要。

注2: 切削油請充分使用具有潤滑性之水性切屑油。



High Speed Cutting
& High Hard Cutting



TOPTAP PRECISION TOOLS

TOPTAP PRECISION TOOLS

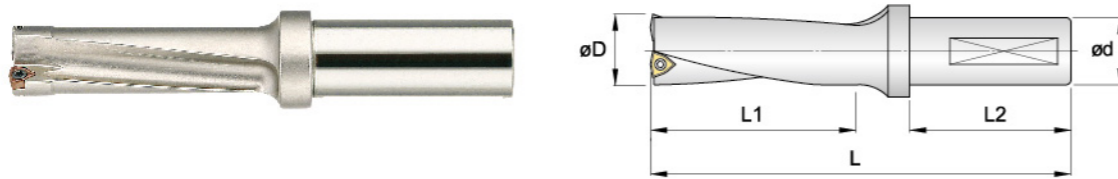

Micro Diameter

Type No. 型號	Applicable Insert 適用刀片	尺寸 Dimension					配件 Accessory	
		D	d	L	L1	L2		
WJ14-WCMX03	WCMX030208	14	20	110	42	50	FC5-2510	T8
WJ15-WCMX03	WCMX030208	15	20	113	45	50	FC5-2510	T8
WJ16-WCMX03	WCMX030208	16	20	116	48	50	FC5-2510	T8
WJ17-WCMX03	WCMX030208	17	20	119	51	50	FC5-2510	T8
WJ18-WCMX03	WCMX030208	18	20	122	54	50	FC5-2510	T8
WJ19-WCMX03	WCMX030208	19	20	125	57	50	FC5-2510	T8

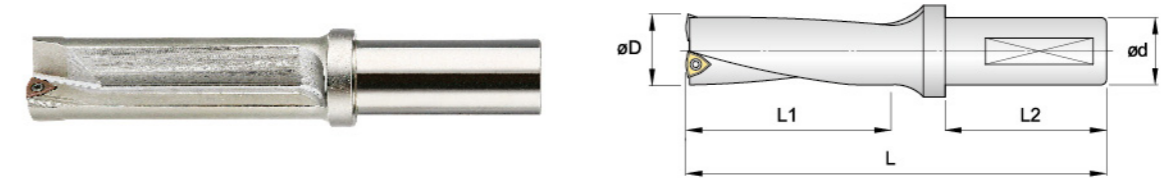

Micro Diameter

Type No. 型號	Applicable Insert 適用刀片	尺寸 Dimension					配件 Accessory	
		D	d	L	L1	L2		
WJ25-WCMX05	WCMX050308	25	25	155	75	60	FC5-3010	T10
WJ26-WCMX05	WCMX050308	26	25	158	78	60	FC5-3010	T10
WJ27-WCMX05	WCMX050308	27	25	161	81	60	FC5-3010	T10
WJ28-WCMX05	WCMX050308	28	25	164	84	60	FC5-3010	T10
WJ29-WCMX05	WCMX050308	29	25	167	87	60	FC5-3010	T10
WJ30-WCMX05	WCMX050308	30	25	170	90	60	FC5-3010	T10

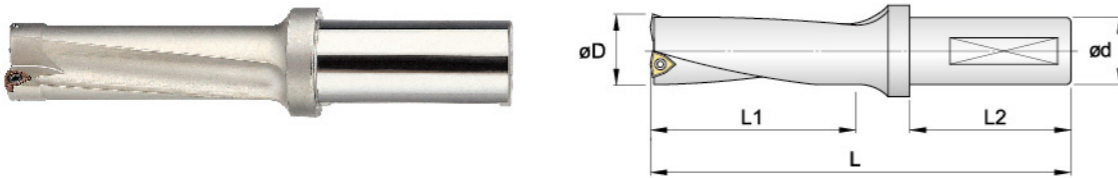

Micro Diameter

Type No. 型號	Applicable Insert 適用刀片	尺寸 Dimension					配件 Accessory	
		D	d	L	L1	L2		
WJ20-WCMX04	WCMX040208	20	25	133	60	55	FC5-2510	T8
WJ21-WCMX04	WCMX040208	21	25	136	63	55	FC5-2510	T8
WJ22-WCMX04	WCMX040208	22	25	139	66	55	FC5-2510	T8
WJ23-WCMX04	WCMX040208	23	25	142	69	55	FC5-2510	T8
WJ24-WCMX04	WCMX040208	24	25	145	72	55	FC5-2510	T8

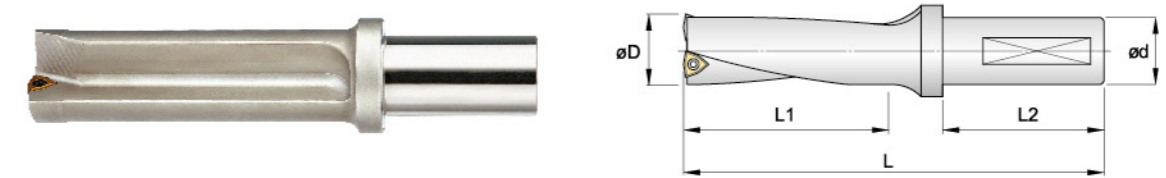

Micro Diameter

Type No. 型號	Applicable Insert 適用刀片	尺寸 Dimension					配件 Accessory	
		D	d	L	L1	L2		
WJ31-WCMX06	WCMX060308	31	32	178	93	60	FC5-3510	T15
WJ32-WCMX06	WCMX060308	32	32	181	96	60	FC5-3510	T15
WJ33-WCMX06	WCMX060308	33	32	184	99	60	FC5-3510	T15
WJ34-WCMX06	WCMX060308	34	32	187	102	60	FC5-3510	T15
WJ35-WCMX06	WCMX060308	35	32	190	105	60	FC5-3510	T15
WJ36-WCMX06	WCMX060308	36	32	193	108	60	FC5-3510	T15
WJ37-WCMX06	WCMX060308	37	32	196	111	60	FC5-3510	T15
WJ38-WCMX06	WCMX060308	38	32	199	114	60	FC5-3510	T15
WJ39-WCMX06	WCMX060308	39	32	202	117	60	FC5-3510	T15

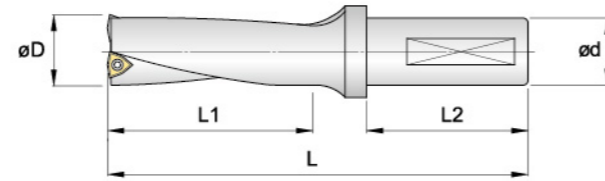
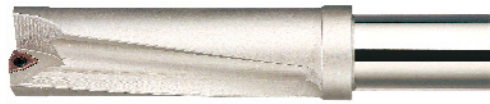

Micro Diameter

Type No. 型號	Applicable Insert 適用刀片	尺寸 Dimension					配件 Accessory	
		D	d	L	L1	L2		
WJ40-WCMX08	WCMX080412	40	40	223	120	70	FC5-4010	T15
WJ41-WCMX08	WCMX080412	41	40	226	123	70	FC5-4010	T15
WJ42-WCMX08	WCMX080412	42	40	229	126	70	FC5-4010	T15
WJ43-WCMX08	WCMX080412	43	40	232	129	70	FC5-4010	T15
WJ44-WCMX08	WCMX080412	44	40	235	132	70	FC5-4010	T15
WJ45-WCMX08	WCMX080412	45	40	238	135	70	FC5-4010	T15
WJ46-WCMX08	WCMX080412	46	40	241	138	70	FC5-4010	T15
WJ47-WCMX08	WCMX080412	47	40	244	141	70	FC5-4010	T15
WJ48-WCMX08	WCMX080412	48	40	247	144	70	FC5-4010	T15
WJ49-WCMX08	WCMX080412	49	40	250	147	70	FC5-4010	T15
WJ50-WCMX08	WCMX080412	50	40	253	150	70	FC5-4010	T15

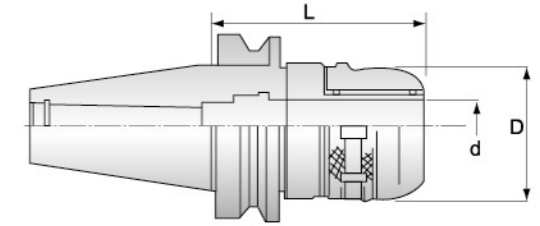

Micro Diameter

Type No. 型號	D	L	C	Collet
BT30-KCH20-80	6-20	80	54	SC20
BT40-KCH20-80	6-20	80	54	SC20
BT40-KCH20-105	6-20	105	54	SC20
BT40-KCH20-135	6-20	135	54	SC20
BT40-KCH32-105	6-32	105	68	SC32
BT50-KCH20-105	6-20	105	54	SC20
BT50-KCH20-135	6-20	135	54	SC20
BT50-KCH20-165	6-20	165	54	SC20
BT50-KCH32-105	6-32	105	68	SC32
BT50-KCH32-135	6-32	135	68	SC32
BT50-KCH32-165	6-32	165	68	SC32
BT50-KCH32-200	6-32	200	68	SC32
BT50-KCH42-105	6-42	105	87	SC42

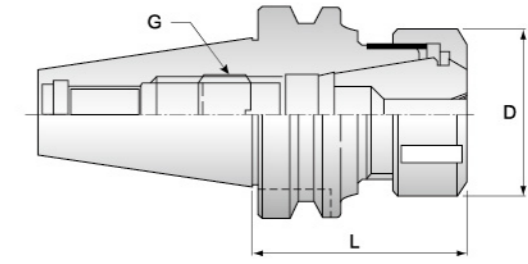
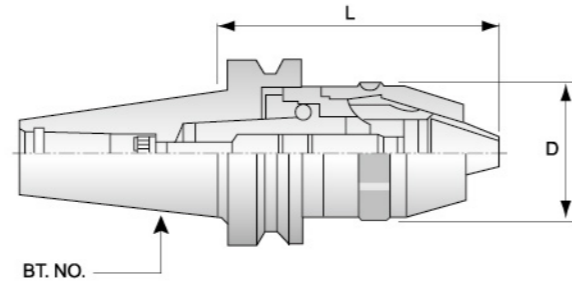

Micro Diameter

Type No. 型號	Clamping Range(ømm)	D	L	
			Minimum	Maximum
BT30-APU08-80	1-8	36.3	75	82
BT30-APU13-100	1-13	51.5	97	104.5
BT40-APU08-80	1-8	36.3	79	86.5
BT40-APU13-100	1-13	51.5	98	109
BT40-APU16-130	3-16	58	116	130
BT50-APU08-95	1-8	36.3	90	97.5
BT50-APU13-120	1-13	51.5	109	120
BT50-APU13-180	1-13	51.5	169	180
BT50-APU16-130	3-16	58	116	130
BT50-APU16-190	3-16	58	176	190

Micro Diameter

※ () 代表M型羅帽

Type No. 型號	Capacity	L	D	Collet Type
BT30-ER16-60	0.5-10	60	28 (22)	ER-16
BT30-ER16-100	0.5-10	100	28 (22)	ER-16
BT30-ER20-60	1-13	60	34 (28)	ER-20
BT30-ER20-100	1-13	100	34 (28)	ER-20
BT30-ER25-60	1-16	60	42	ER-25
BT30-ER25-100	1-16	100	42	ER-25
BT30-ER32-60	2-20	60	50	ER-32
BT30-ER32-100	2-20	100	50	ER-32
BT40-ER16-70	0.5-10	70	28 (22)	ER-16
BT40-ER16-100	0.5-10	100	28 (22)	ER-16
BT40-ER16-150	0.5-10	150	28	ER-16
BT40-ER20-70	1-13	70	34 (28)	ER-20
BT40-ER20-100	1-13	100	34 (28)	ER-20
BT40-ER20-150	1-13	50	34	ER-20
BT40-ER25-70	1-16	70	42	ER-25
BT40-ER25-100	1-16	100	42	ER-25
BT40-ER32-70	2-20	70	50	ER-32
BT40-ER32-100	2-20	100	50	ER-32
BT40-ER32-150	2-20	150	50	ER-32
BT40-ER40-80	3-26	80	63	ER-40
BT40-ER40-100	3-26	100	63	ER-40
BT50-ER16-100	0.5-10	100	28	ER-16
BT50-ER16-150	0.5-10	150	28	ER-16
BT50-ER20-100	1-13	100	34	ER-20
BT50-ER20-150	1-13	150	34	ER-20
BT50-ER25-100	1-16	100	42	ER-25
BT50-ER25-150	1-16	150	42	ER-25
BT50-ER32-100	2-20	100	50	ER-32
BT50-ER32-150	2-20	150	50	ER-32



NBJ16精搪刀桿 Minor Diameter Bore



NBH2084精搪刀桿 Minor Diameter Bore

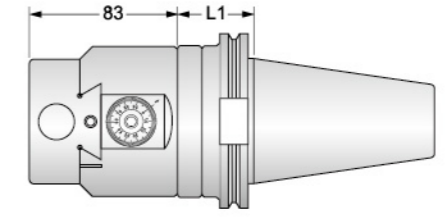
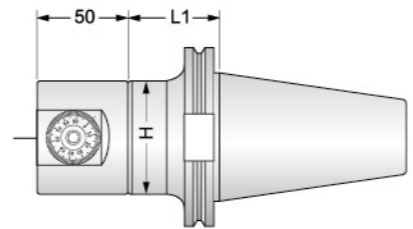

NBJ16微調精搪孔系統

Type No. 型號	加工內徑	H-System	L1
NT40-NBJ16	ø6~ø51	H63	55
NT50-NBJ16	ø6~ø51	H63	65
BT40-NBJ16	ø6~ø51	H63	55
BT50-NBJ16	ø6~ø51	H63	65

Type No. 型號	加工內徑	H-System	L1
SK40-NBJ16	ø6~ø51	H63	60
SK50-NBJ16	ø6~ø51	H63	50
HSK63A-NBJ16	ø6~ø51	H63	60

NBH2084微調精搪孔系統

Type No. 型號	加工內徑
R8-NBH2084	ø8~ø280
NT30-NBH2084	ø8~ø280
NT40-NBH2084	ø8~ø280
NT50-NBH2084	ø8~ø280
MT4-NBH2084	ø8~ø280

Type No. 型號	加工內徑
BT40-NBH2084	ø8~ø280
BT50-NBH2084	ø8~ø280
SK40-NBH2084(DIN69871)	ø8~ø280
SK50-NBH2084(DIN69871)	ø8~ø280
MT5-NBH2084	ø8~ø280

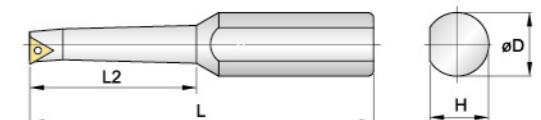
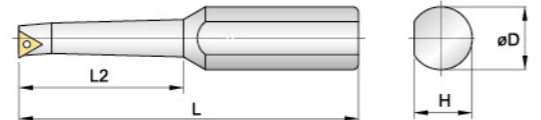

Ø16 mm NBJ16精搪刀桿盒裝組 8 Pcs Boring Set

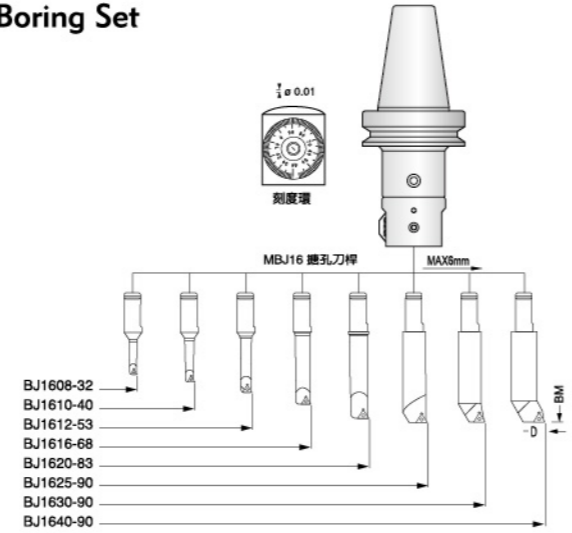

Ø20 mm NBH2084精搪刀桿盒裝組 8 Pcs Boring Set

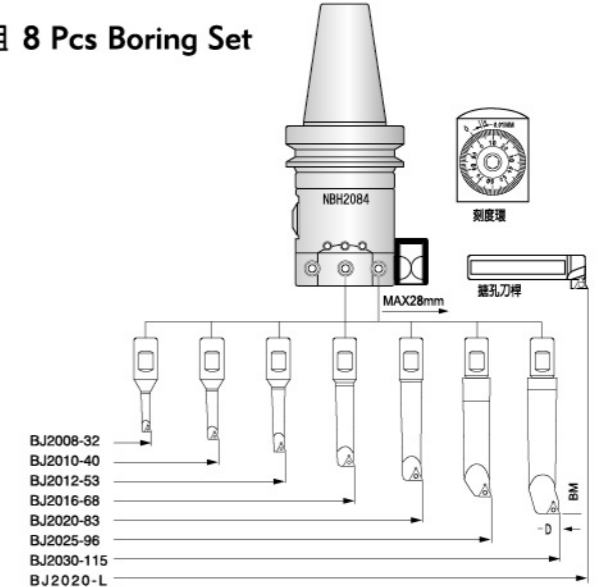

Micro Diameter

Type No. 型號	Applicable Insert 適用刀片	加工內徑	尺寸 Dimension				配件 Accessory	
			D	d	L1	H		
BJ1608-32	TBGT060102L	ø8~ø11	16	80	33.5	15	FC5-2010	T6
BJ1610-40	TBGT060104L	ø10~ø13	16	86.5	41.8	15	FC5-2010	T6
BJ1612-53	TBGH090202L	ø12~ø15	16	98	55.2	15	FC5-2010	T8
BJ1616-68	TBGH090204L	ø16~ø21	16	110	70.8	15	FC5-2010	T10
BJ1620-83	TBGH110302L	ø20~ø26	16	125	85	15	FC5-2010	T10
BJ1625-90	TBGH110302L	ø25~ø31	16	128	90	15	FC5-2010	T10
BJ1630-90	TBGH110304L	ø31~ø40	16	128	90	15	FC5-2010	T10
BJ1640-90	TBGH110304L	ø40~ø50	16	128	90	15	FC5-2010	T10

Micro Diameter

Type No. 型號	Applicable Insert 適用刀片	加工內徑	尺寸 Dimension				配件 Accessory	
			D	d	L1	H		
BJ2008-32	TBGT060102L	ø8~ø11	20	75	32	18	FC5-2010	T6
BJ2010-40	TBGT060104L	ø10~ø13	20	75	38	18	FC5-2010	T6
BJ2012-53	TBGH090202L	ø12~ø17	20	85	48	18	FC5-2510	T8
BJ2016-68	TBGH090204L	ø16~ø21	20	100	66	18	FC5-2510	T8
BJ2020-83	TBGH110302L/04L	ø20~ø130	20	115	83	18	FC5-3010	T10
BJ2025-96	TBGH110302L/04L	ø25~ø135	20	128	96	18	FC5-3010	T10
BJ2030-115	TBGH110302L/04L	ø31~ø140	20	147	115	18	FC5-3010	T10
BJ2020-L	TBGH110302L/04L	ø40~ø280	20	97	18	18	FC5-3010	T10

TOPTAP PRECISION TOOLS

TOPTAP PRECISION TOOLS



New

SSD 4° 高速精密筒夾 SSD 4° Collet

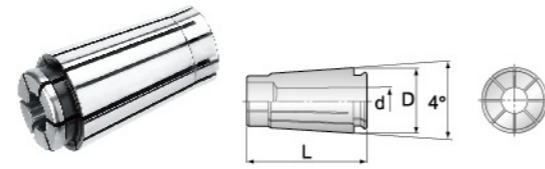
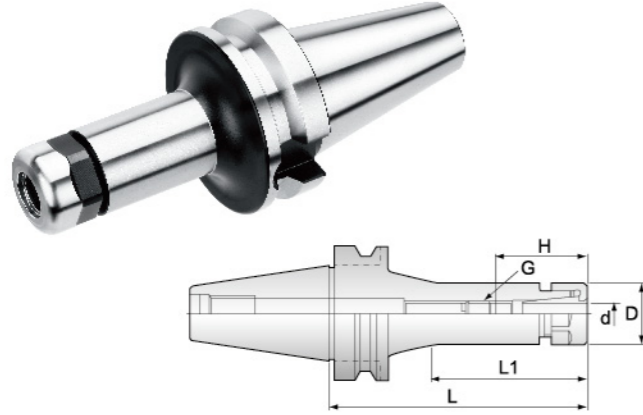

Order Code		D	L
Collet series	Ød		
SSD6	2, 3, 4, 5, 6	10.55	25
SSD10	3, 4, 5, 6, 7, 8, 9, 10	15.6	30
SSD16	4, 5, 6, 7, 8, 9, 10, 11, 12, 13, 14, 15, 16	24.6	45

Type No. 型號	Range (d)	L	L1
BT30-SSD6-60	2-6	60	38
BT30-SSD6-90	2-6	90	50
BT30-SSD10-60	2-10	60	38
BT30-SSD10-90	2-10	90	68
BT30-SSD16-60	3-16	60	38
BT30-SSD16-90	3-16	90	68
BT30-SSD20-60	4-20	60	37
BT30-SSD20-80	6-25	80	37
BT40-SSD6-60	2-6	60	33
BT40-SSD6-90	2-6	90	50
BT40-SSD6-120	2-6	120	50
BT40-SSD10-60	2-10	60	33
BT40-SSD10-90	2-10	90	63
BT40-SSD10-120	2-10	120	70
BT40-SSD10-150	2-10	150	88
BT40-SSD16-60	3-16	60	33
BT40-SSD16-90	3-16	90	63
BT40-SSD16-120	3-16	120	93
BT40-SSD16-150	3-16	150	123
BT40-SSD20-60	4-20	60	33
BT40-SSD20-90	4-20	90	63
BT40-SSD20-120	4-20	120	93
BT40-SSD20-150	4-20	150	123
BT40-SSD25-80	4-25	80	53
BT40-SSD25-120	6-25	120	93
BT50-SSD6-100	2-6	100	50
BT50-SSD 6-150	2-6	150	50
BT50-SSD10-100	2-10	100	62
BT50-SSD10-150	2-10	150	70
BT50-SSD16-100	3-16	100	62
BT50-SSD16-150	3-16	150	112
BT50-SSD16-200	3-16	200	162
BT50-SSD20-100	4-20	100	62
BT50-SSD20-150	4-20	150	112
BT50-SSD20-200	4-20	200	162
BT50-SSD25-100	6-25	100	62
BT50-SSD25-150	6-25	150	112
BT50-SSD25-200	6-25	200	162

New

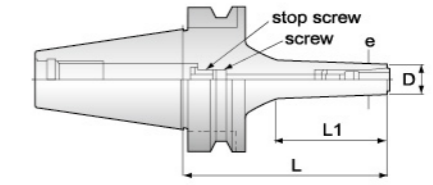

Fig. 1

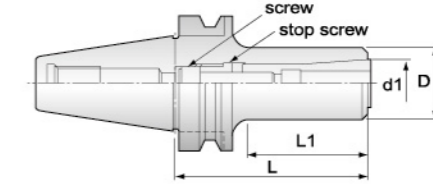
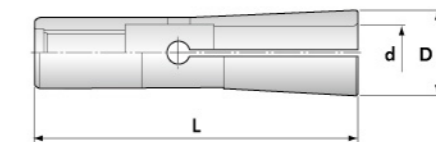

Fig. 2

Type No. 型號	Gripping Range	L	D	Fig	D
BT30-SDC6-60	2-6	60	13	1	DC6
BT30-SDC6-90	2-6	90	13	1	DC6
BT40-SDC6-60	2-6	60	13	1	DC6
BT40-SDC6-90	2-6	90	13	1	DC6
BT40-SDC6-120	2-6	120	13	1	DC6
BT40-SDC6-150	2-6	150	13	1	DC6
BT40-SDC8-90	3-8	90	22	1	DC8
BT40-SDC8-120	3-8	120	22	1	DC8
BT40-SDC10-90	3-10	90	28	2	DC10
BT40-SDC10-120	3-10	120	28	2	DC10
BT40-SDC12-70	3-12	70	34	2	DC12
BT40-SDC12-90	3-12	90	34	2	DC12
BT50-SDC10-110	3-10	110	28	2	DC10

SDC 高速後拉筒夾 SDC Collet (for end mill)



Order Code		L	ØD
Collet series	Ød		
SDC6	3, 4, 6	36	9.6
SDC8	3, 4, 6, 8	45	15
SDC10	3, 4, 6, 8, 10	52	19.1
SDC12	3, 4, 5, 6, 8, 10, 12	60	22



TOPTAP PRECISION TOOLS

TOPTAP PRECISION TOOLS



Micro Diameter

Type No. 型號	Capacity	Collet Set
NT30-KCH20	6-20	6, 8, 10, 12, 16
NT40-KCH32	6-32	6, 8, 10, 12, 16, 20, 25
NT50-KCH32	6-32	6, 8, 10, 12, 16, 20, 25



Micro Diameter

Type No. 型號	Capacity	Collet Set
NT30-OZ25	3-25	7 PS : 6, 8, 10, 12, 16, 20, 25
NT30-OZ25		15PS : 3, 4, 5, 6, 7, 8, 9, 10, 11, 12, 13, 16, 18, 20, 25
NT40-OZ25		
NT40-OZ32	6-32	8 PS : 6, 8, 10, 12, 16, 20, 25, 32
NT50-OZ32		15PS : 6, 7, 8, 9, 10, 11, 12, 13, 14, 15, 16, 18, 20, 25, 32



Micro Diameter

ER11		ER20		ER25		ER32		ER40	
Ordering Code	Range (mm)	Ordering Code	Range (mm)	Ordering Code	Range (mm)	Ordering Code	Range (mm)	Ordering Code	Range (mm)
ER11-1.0	1.0-0.5	ER20-2	2-1	ER25-2	2-1	ER32-3	3-2	ER40-4	4-3
ER11-1.5	1.5-1.0	ER20-3	3-2	ER25-3	3-2	ER32-4	4-3	ER40-5	5-4
ER11-2.0	2.0-1.5	ER20-4	4-3	ER25-4	4-3	ER32-5	5-4	ER40-6	6-5
ER11-2.5	2.5-2.0	ER20-5	5-4	ER25-5	5-4	ER32-6	6-5	ER40-7	7-6
ER11-3.0	3.0-2.5	ER20-6	6-5	ER25-6	6-5	ER32-7	7-6	ER40-8	8-7
ER11-3.5	3.5-3.0	ER20-7	7-6	ER25-7	7-6	ER32-8	8-7	ER40-9	9-8
ER11-4.0	4.0-3.5	ER20-8	8-7	ER25-8	8-7	ER32-9	9-8	ER40-10	10-9
ER11-4.5	4.5-4.0	ER20-9	9-8	ER25-9	9-8	ER32-10	10-9	ER40-11	11-10
ER11-5.0	5.0-4.5	ER20-10	10-9	ER25-10	10-9	ER32-11	11-10	ER40-12	12-11
ER11-5.5	5.5-5.0	ER20-11	11-10	ER25-11	11-10	ER32-12	12-11	ER40-13	13-12
ER11-6.0	6.0-5.5	ER20-12	12-11	ER25-12	12-11	ER32-13	13-12	ER40-14	14-13
ER11-6.5	6.5-6.0	ER20-13	13-12	ER25-13	13-12	ER32-14	14-13	ER40-15	15-14
ER11-7.0	7.0-6.5			ER25-14	14-13	ER32-15	15-14	ER40-16	16-15
ER16				ER25-15	15-14	ER32-16	16-15	ER40-17	17-16
ER16-1	1-0.5			ER25-16	16-15	ER32-17	17-16	ER40-18	18-17
ER16-2	2-1					ER32-18	18-17	ER40-19	19-18
ER16-3	3-2					ER32-19	19-18	ER40-20	20-19
ER16-4	4-3					ER32-20	20-19	ER40-21	21-20
ER16-5	5-4							ER40-22	22-21
ER16-6	6-5							ER40-23	23-22
ER16-7	7-6							ER40-24	24-23
ER16-8	8-7							ER40-25	25-24
ER16-9	9-8							ER40-26	26-25
ER16-10	10-9								

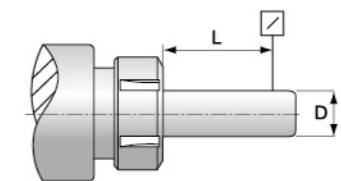
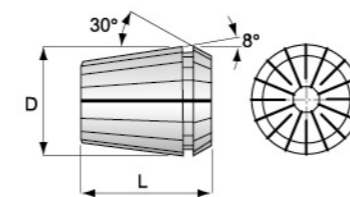

Collet Dimensions

Type No. 型號	ER11	ER16	ER20	ER25	ER32	ER40
D	11.5	17	21	26	33	41
L	18	27	31	35	40	46

Concentricity of Collet DIN 6499

D (mm)	D (mm)	DIN 6499		
		Class2	Class1	ClassG
6	1.0-1.4	0.015	0.01	0.005
10	1.5-2.9			
16	3.0-5.9			
25	6.0-9.9	0.02	0.015	0.01
40	10.0-17.9			
50	18.0-26.9			
60	27.0-34.9			

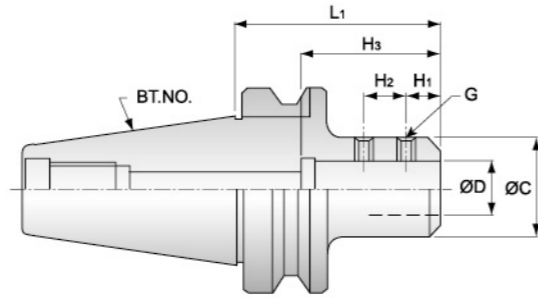

Micro Diameter

Type No. 型號	D	C	H	L	H1	H2	H3
BT30-SLA6-60	6	25	32	60	10	10	M6
BT30-SLA8-60	8	28	36	60	12	12	M8
BT30-SLA10-60	10	35	40	60	15	12	M8
BT30-SLA12-60	12	40	45	60	18	16	M10
BT30-SLA16-75	16	45	50	75	20	18	M10
BT30-SLA20-75	20	50	60	75	25	20	M12
BT30-SLA25-75	25	55	65	75	24	25	M12
BT40-SLA6-75	6	25	32	75	10	10	M6
BT40-SLA8-75	8	28	36	75	12	12	M8
BT40-SLA10-75	10	35	40	75	15	12	M8
BT40-SLA12-75	12	40	45	75	18	16	M10
BT40-SLA14-75	14	42	45	75	18	16	M10
BT40-SLA16-75	16	45	50	75	20	18	M10
BT40-SLA18-75	18	48	50	75	20	18	M12
BT40-SLA20-75	20	50	60	75	25	20	M12
BT40-SLA25-75	25	60	65	75	24	25	M16
BT40-SLA32-90	32	60	70	90	24	28	M16
BT40-SLA40-105	40	80	80	105	24	28	M16
BT40-SLA42-105	42	80	80	105	24	28	M20
BT50-SLA6-105	6	25	32	105	10	10	M6
BT50-SLA8-105	8	28	36	105	12	12	M8
BT50-SLA10-105	10	35	40	105	15	12	M8
BT50-SLA12-105	12	40	45	105	18	16	M10
BT50-SLA14-105	14	42	45	105	18	16	M10
BT50-SLA16-105	16	45	50	105	20	18	M10
BT50-SLA18-105	18	48	55	105	20	18	M10
BT50-SLA20-105	20	50	60	105	25	20	M12
BT50-SLA20-150	20	50(40)	60	150	25	20	M12
BT50-SLA20-200	20	50(40)	60	200	25	20	M12
BT50-SLA25-105	25	60	60	105	25	22	M16
BT50-SLA25-150	25	60(50)	65	150	24	25	M16
BT50-SLA25-200	25	60(50)	65	200	24	25	M16
BT50-SLA25-250	25	60(50)	65	250	24	25	M16
BT50-SLA32-105	32	60	70	105	24	28	M20
BT50-SLA32-150	32	60(50)	70	150	24	28	M20
BT50-SLA32-200	32	60(50)	70	200	24	28	M20
BT50-SLA32-250	32	60(50)	70	250	24	28	M20
BT50-SLA40-105	40	80	80	105	30	32	M20
BT50-SLA42-105	42	80	80	105	30	32	M20
BT50-SLA42-150	42	80	80	150	30	32	M20
BT50-SLA42-200	42	80	80	200	30	32	M20
BT50-SLA50.8-120	50.8	95	90	120	30	32	M20

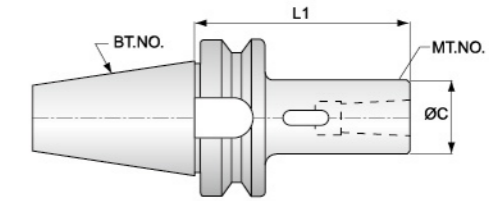
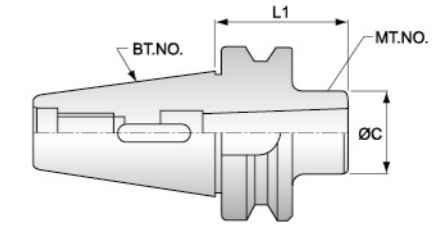

Micro Diameter

Type No. 型號	Fig	MT. No.	Ø C	L1
BT30-MT1-45	1	MT1	25	45
BT30-MT2-60	1	MT2	32	60
BT30-MT3-80	1	MT3	40	80
BT40-MT1-45	1	MT1	25	45
BT40-MT1-120	2	MT1	25	120
BT40-MT2-45	1	MT2	32	45
BT40-MT2-120	2	MT2	32	120
BT40-MT3-75	1	MT3	40	75
BT40-MT3-135	2	MT3	40	135
BT40-MT4-90	1	MT4	50	90
BT50-MT1-45	1	MT1	25	45
BT50-MT1-120	2	MT1	25	120
BT50-MT1-180	2	MT1	32	180
BT50-MT2-45	1	MT2	32	45
BT50-MT2-135	2	MT2	32	135
BT50-MT2-185	2	MT2	32	185
BT50-MT3-45	1	MT3	40	45
BT50-MT3-150	2	MT3	40	150
BT50-MT3-180	2	MT3	40	180
BT50-MT4-75	1	MT4	50	75
BT50-MT4-180	2	MT4	50	180
BT50-MT5-105	1	MT5	65	105
BT50-MT5-210	2	MT5	65	210

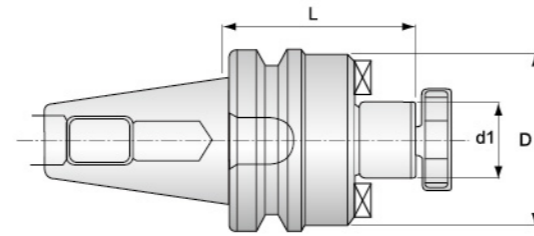

刀盤使用刀杆 (平面銑刀架) Face Mill Holder

Type No. 型號	D1	L
BT40-FMB22-90	22	90
BT40-FMB22-120	22	120
BT40-FMB22-150	22	150
BT40-FMB22-200	22	200
BT50-FMB22-150	22	150

Type No. 型號	D1	L
BT50-FMB22-200	22	200
BT50-FMB22-250	22	250
BT50-FMB22-300	22	300
BT50-FMB22-350	22	350
BT50-FMB22-400	22	400

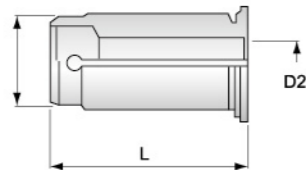

SC筒夾 SC Spring Collets

Type No. 型號	Collet	Model
SC20	6, 8, 10, 12, 14, 16	64
SC32	6, 8, 10, 12, 16, 20, 25	71
SC42	6, 8, 10, 12, 16, 20, 25, 32	80



扳手 Wrench For ASC Milling Chuck
W20, W32, W42

Type No. 型號	D1	Chuck
W20	45	ASC20
W32	76	ASC32
W42	76	ASC42

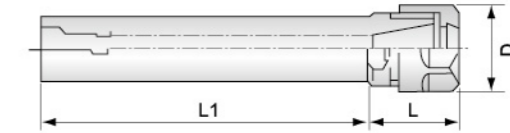

Straight Shank C20, C25, C32, C40

Type No. 型號	L1	L	D
C20-ER16-50	50	30	28
C20-ER16-100	100	30	28
C20-ER16-150	150	30	28
C20-ER20-50	50	36	34
C20-ER20-100	100	36	34
C20-ER20-150	150	36	34
C20-ER25-50	50	46	42
C20-ER25-100	100	46	42
C20-ER25-150	150	46	42
C25-ER16-100	100	30	28
C25-ER16-150	150	30	28

Type No. 型號	L1	L	D
C25-ER20-150	150	36	34
C25-ER25-100	100	46	42
C25-ER25-150	150	46	42
C25-ER32-80	80	54	50
C25-ER40-100	100	55	63
C32-ER25-60	60	46	42
C32-ER32-100	100	54	50
C32-ER40-100	100	55	63
C40-ER32-100	100	54	50
C40-ER40-100	100	55	63



直柄ER夾頭組

本體 D1 x L1	筒夾型號	筒夾規格
ø 20 x L50	ER16 夾持能力 ø0.5 ~ ø10	1 ~ 0.5
		2 ~ 1
		3 ~ 2
		4 ~ 3
ø 20 x L100		5 ~ 4
		6 ~ 5
		8 ~ 7
ø 20 x L150		9 ~ 8
		10 ~ 9
ø 20 x L200		共10只

本體 D1 x L1	筒夾型號	筒夾規格	
ø 20 x L50	ER20 夾持能力 ø1 ~ ø13	2 ~ 1	
		3 ~ 2	
		4 ~ 3	
		6 ~ 5	
		7 ~ 6	
		8 ~ 7	
		9 ~ 8	
		11 ~ 10	
		12 ~ 11	
		13 ~ 12	
		ø 20 x L100	共12只

TOPTAP PRECISION TOOLS

TOPTAP PRECISION TOOLS

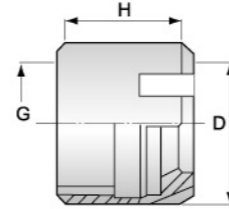

螺母系列 Clamping Nuts

Type No. 型號	Fig.	D	H	G	Collet Type
CN11	1	19	13	M14XP0.75	ER11
CN16	1	28	17.5	M22XP1.5	ER16
CN20	1	34	19	M25XP1.5	ER20
CN25	2	42	20	M32XP1.5	ER25
CN32	2	50	22.5	M40XP1.5	ER32
CN40	2	63	29	M50XP1.5	ER40
CNM11	3	16	12	M13XP0.75	ER11
CNM16	3	22	18	M19XP1.0	ER16
CNM20	3	28	19	M24XP1.0	ER20

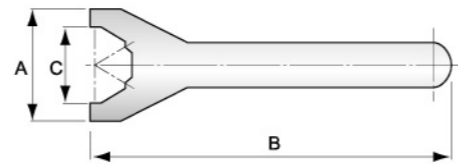

扳手系列 Wrench Series

Type No. 型號	Fig.	A	C	B	Collet Type
W16		45	25	137	ER16
W20		54	30	162	ER20
W25	1	65	37	206	ER25
W32	1	75	46.5	253	ER32
W40	1	90	58	289	ER40
Wm11	2	17	8.5	95	ER11
Wm16	2	22.5	12.5	117	ER16
Wm20	2	28.5	15.5	129	ER20

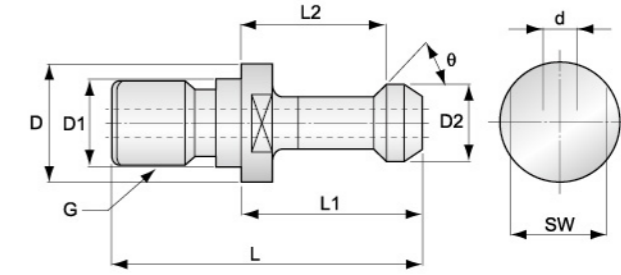

Micro Diameter

Type of Pull Stud 型號	L	L1	L2	D	D1	D2	θ	G	SW
P30T-1	43	23	18	16.5	12.5	11	45°	M12	13
P30T-2	43	23	18	16.5	12.5	11	60°	M12	13
P40T-1	60	35	28	23	17	15	45°	M16	19
P40T-2	60	35	28	23	17	15	60°	M16	19
P40T-90	60	35	28	23	17	15	90°	M16	19
P50T-1	85	45	35	38	25	23	45°	M24	30
P50T-2	85	45	35	38	25	23	60°	M24	30
P50T-90	85	45	35	38	25	23	90°	M24	30



刀庫主軸清潔棒 (可替換式片)
Spindle Taper Wipers

Type No. 型號	Type No. 型號
CL-30	#30
CL-40	#40
CCL-50	#50



Vertical/Horizontal
BT Tool Holder Locking Device

立橫兩用BT刀軸鎖刀座

BT30, BT40, BT50三種規格。

特性：

- 1.操作簡單，刀軸容易固定。
- 2.立式、橫式兩用。
- 3.不需再調整角度即可使用。
- 4.置刀架使用鋁合金，保護刀把。



切削數據表 Recommend Cutting Conditions

切削條件：極細微粒炭化鎢 2刃立銑刀 WJ-352 / WJ-452

切削數據表 Recommend Cutting Conditions

切削條件：極細微粒炭化鎢 4刃立銑刀 WJ-354 / WJ-454



TOPTAP PRECISION TOOLS

TOPTAP PRECISION TOOLS

被切削材	鐵材、碳素鋼、鑄鐵 合金鋼、工具鋼、模具鋼		合金鋼、工具鋼 模具鋼、熱處理鋼		合金鋼、工具鋼、不銹鋼 模具鋼、熱處理鋼		熱處理鋼 鈦合金		熱處理鋼、耐熱合金 鎳鎢合金	
	SS41,S45C,FC,FCD SCr,SCM,SNC,SNM, SK,SKS,SKT,SKD PDS1, PDS3,S50C,YK30		SCr,SCM,SNC,SNM, SKD,NAK101 PDS5,P20		SCr,SCM,SNC,SNM, SKD,NAK55,NAK80 P20S,FDAC,SUS420J2 SUS304,SUS316		Ti-6Al-4v		inconel	
被切削材硬度 立銑刀刃徑 mm	HRC30以下		HRC30-35		HRC35-40		HRC40-45		HRC45-50	
	轉速 轉/分	進給 mm/分	轉速 轉/分	進給 mm/分	轉速 轉/分	進給 mm/分	轉速 轉/分	進給 mm/分	轉速 轉/分	進給 mm/分
D1.0	16.000	64	9.500	40	8.600	38	7.600	36	3.200	13
D2.0	9.500	88	5.700	56	5.100	50	4.500	44	1.900	19
D3.0	7.400	120	4.500	76	4.000	68	3.600	60	1.500	25
D4.0	6.400	160	3.800	96	3.400	86	3.000	80	1.270	32
D5.0	5.700	200	3.400	120	3.100	110	2.700	96	1.150	40
D6.0	5.300	256	3.200	152	2.900	136	2.500	120	1.060	50
D8.0	4.000	256	2.400	152	2.200	136	1.900	120	800	50
D10.0	3.200	256	1.900	152	1.700	136	1.500	120	640	50
D12.0	2.600	250	1.600	152	1.450	136	1.300	120	530	50
D16.0	2.000	192	1.200	116	1.100	104	950	92	400	38
D18.0	1.800	176	1.100	104	1.000	94	850	80	350	33
D20.0	1.600	152	920	92	860	83	760	72	320	30
D25.0	1.300	128	760	72	680	65	600	58	250	24

最大切削量

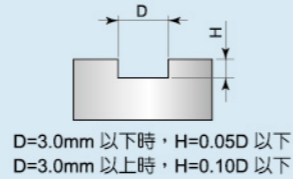
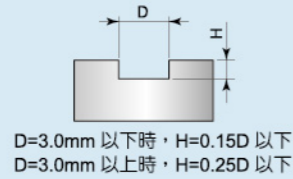

被切削材硬度 立銑刀刃徑 mm	HRC30以下		HRC30-35		HRC35-40		HRC40-45		HRC45-50	
	轉速 轉/分	進給 mm/分	轉速 轉/分	進給 mm/分	轉速 轉/分	進給 mm/分	轉速 轉/分	進給 mm/分	轉速 轉/分	進給 mm/分
D1.0	16.000	80	9.500	50	8.600	48	7.600	40	3.200	16
D2.0	9.500	110	5.700	70	5.100	62	4.500	55	1.900	23
D3.0	7.400	150	4.500	95	4.000	85	3.600	75	1.500	31
D4.0	6.400	200	3.800	120	3.400	107	3.000	100	1.270	40
D5.0	5.700	250	3.400	150	3.100	137	2.700	120	1.150	51
D6.0	5.300	320	3.200	190	2.900	170	2.500	150	1.060	64
D8.0	4.000	320	2.400	190	2.200	170	1.900	150	800	64
D10.0	3.200	320	1.900	190	1.700	170	1.500	150	640	64
D12.0	2.600	310	1.600	190	1.450	170	1.300	150	530	64
D16.0	2.000	240	1.200	145	1.100	130	950	115	400	48
D18.0	1.800	220	1.100	130	1.000	120	850	100	350	42
D20.0	1.600	190	920	115	860	105	760	90	320	38
D25.0	1.300	160	760	90	680	81	600	72	250	30

最大切削量

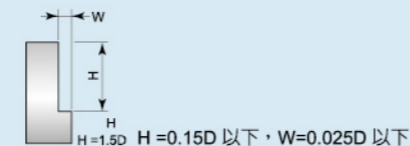
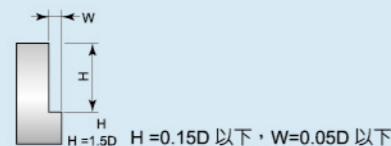

被切削材	鐵材、碳素鋼、鑄鐵 合金鋼、工具鋼、模具鋼		合金鋼、工具鋼 模具鋼、熱處理鋼		合金鋼、工具鋼、不銹鋼 模具鋼、熱處理鋼		熱處理鋼 鈦合金		熱處理鋼、耐熱合金 鎳鎢合金	
	SS41,S45C,FC,FCD SCr,SCM,SNC,SNM, SK,SKS,SKT,SKD PDS1, PDS3,S50C,YK30		SCr,SCM,SNC,SNM, SKD,NAK101 PDS5,P20		SCr,SCM,SNC,SNM, SKD,NAK55,NAK80 P20S,FDAC,SUS420J2 SUS304,SUS316		Ti-6Al-4v		inconel	
被切削材硬度 立銑刀刃徑 mm	HRC30以下		HRC30-35		HRC35-40		HRC40-45		HRC45-50	
	轉速 轉/分	進給 mm/分	轉速 轉/分	進給 mm/分	轉速 轉/分	進給 mm/分	轉速 轉/分	進給 mm/分	轉速 轉/分	進給 mm/分
D3.0	7.400	220	4.500	140	4.000	130	3.600	110	1.500	46
D4.0	6.400	370	3.800	180	3.400	160	3.000	150	1.270	60
D5.0	5.700	370	3.400	220	3.000	200	2.700	180	1.150	76
D6.0	5.300	480	3.200	290	2.900	260	2.500	220	1.060	96
D8.0	4.000	480	2.400	290	2.200	260	1.900	220	800	96
D10.0	3.200	480	1.900	290	1.650	260	1.500	220	640	96
D12.0	2.600	460	1.600	290	1.450	260	1.300	220	530	96
D16.0	2.000	360	1.200	220	1.080	200	950	170	400	72
D18.0	1.800	330	1.050	195	950	180	850	150	350	63
D20.0	1.600	290	950	170	860	150	760	135	320	57
D25.0	1.300	240	760	135	680	120	600	110	250	45

最大切削量

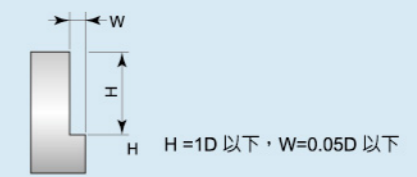
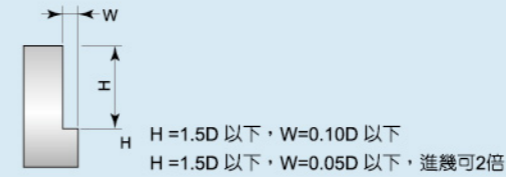

被切削材硬度 立銑刀刃徑 mm	HRC30以下		HRC30-35		HRC35-40		HRC40-45		HRC45-50	
	轉速 轉/分	進給 mm/分	轉速 轉/分	進給 mm/分	轉速 轉/分	進給 mm/分	轉速 轉/分	進給 mm/分	轉速 轉/分	進給 mm/分
D3.0	7.400	176	4.500	110	4.000	104	3.600	90	1.500	37
D4.0	6.400	300	3.800	145	3.400	130	3.000	120	1.270	48
D5.0	5.700	300	3.400	180	3.000	160	2.700	145	1.150	60
D6.0	5.300	380	3.200	230	2.900	210	2.500	180	1.060	75
D8.0	4.000	380	2.400	230	2.200	210	1.900	180	800	75
D10.0	3.200	380	1.900	230	1.650	210	1.500	180	640	75
D12.0	2.600	370	1.600	230	1.450	210	1.300	180	530	75
D16.0	2.000	290	1.200	180	1.080	160	950	140	400	57
D18.0	1.800	260	1.050	160	950	145	850	120	350	50
D20.0	1.600	230	950	140	850	120	760	110	320	45
D25.0	1.300	190	760	110	680	100	600	90	250	38

最大切削量

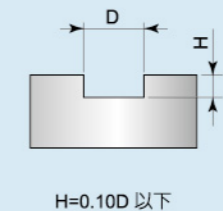
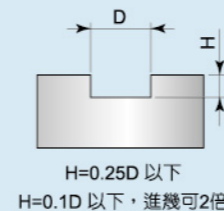



切削數據表 Recommend Cutting Conditions

切削條件：極細微粒炭化鎢 鋁合金專用立銑刀 WJ-145 / WJ-155

被切削材	純鋁		鋁合金 Cu-Mg 系		鋁合金 Si 系		鋁合金 Mg 系		鋁合金 Mg-Si 系		鋁合金 Zn-Mg 系		鑄造鋁合金	
	1070		2014		4032		5052		6061		7075		Ac85	
立銑刀刀徑 mm	轉速	進給	轉速	進給	轉速	進給	轉速	進給	轉速	進給	轉速	進給	轉速	進給
	轉/分	mm/分	轉/分	mm/分	轉/分	mm/分	轉/分	mm/分	轉/分	mm/分	轉/分	mm/分	轉/分	mm/分
D1.0	32.000	800	27.000	150	2.700	400	13.000	500	21.600	500	27.000	640	16.000	500
D2.0	24.000	1.000	20.000	200	2.000	500	10.000	640	16.000	40	20.000	800	12.000	600
D3.0	19.000	1.000	16.000	200	1.600	500	8.000	640	12.800	640	16.000	800	9.600	600
D4.0	16.000	1.000	13.500	200	1.350	500	6.500	640	10.800	640	13.500	800	8.000	600
D5.0	12.000	1.000	10.000	300	1.000	600	5.000	640	8.000	640	10.000	800	6.000	700
D6.0	9.600	1.200	8.000	300	8.000	600	4.000	780	6.400	780	8.000	960	4.800	700
D8.0	8.000	1.200	6.600	250	6.600	700	3.300	780	5.300	780	6.600	960	4.000	700
D10.0	6.000	1.000	5.000	150	5.000	500	2.700	640	4.000	640	5.000	800	3.000	800
D12.0	4.800	1.000	4.000	150	4.000	500	2.000	640	3.200	640	4.000	800	2.400	600

最大切削量

被切削材	純鋁		鋁合金 Cu-Mg 系		鋁合金 Si 系		鋁合金 Mg 系		鋁合金 Mg-Si 系		鋁合金 Zn-Mg 系		鑄造鋁合金	
	1070		2014		4032		5052		6061		7075		Ac85	
立銑刀刀徑 mm	轉速	進給	轉速	進給	轉速	進給	轉速	進給	轉速	進給	轉速	進給	轉速	進給
	轉/分	mm/分	轉/分	mm/分	轉/分	mm/分	轉/分	mm/分	轉/分	mm/分	轉/分	mm/分	轉/分	mm/分
D1.0	32.000	1.900	27.000	1.600	2.700	150	13.000	800	21.600	880	27.000	1.080	16.000	1.000
D2.0	24.000	1.900	20.000	1.600	2.000	200	10.000	800	16.000	880	20.000	1.080	12.000	1.000
D3.0	19.000	1.900	16.000	1.600	1.600	200	8.000	800	12.800	880	16.000	1.080	9.600	1.000
D4.0	16.000	1.900	13.500	1.600	1.350	200	6.500	800	10.800	880	13.500	1.080	8.000	1.000
D5.0	12.000	1.900	10.000	1.600	1.000	300	5.000	800	8.000	880	10.000	1.080	6.000	1.000
D6.0	9.600	1.900	8.000	1.600	8.000	300	4.000	800	6.400	880	8.000	1.080	4.800	1.000
D8.0	8.000	1.900	6.600	1.600	6.600	250	3.300	800	5.300	880	6.600	1.080	4.000	1.000
D10.0	6.000	1.900	5.000	1.600	5.000	150	2.700	800	4.000	880	5.000	1.080	3.000	1.000
D12.0	4.800	1.900	4.000	1.600	4.000	150	2.000	800	3.200	880	4.000	1.080	2.400	1.000

最大切削量



切削數據表 Recommend Cutting Conditions

切削條件：極細微粒炭化鎢 2刃球型立銑刀 WJ-MR / WJ-LR(一般M/C使用)

被切削材	鐵材、碳素鋼、鑄鐵、合金鋼、工具鋼				合金鋼、工具鋼、不鏽鋼、熱處理鋼				熱處理鋼			
	SS41,S45C,FC,FCD,SCr,SCM,SNC,SNM,SK,SKS,SKT,SKD,PDS1,PDS3,S50C,YK30				SCr,SCM,SNC,SNM,SKT,SKD,P20,P20S,NAK55,NAK80,FDAC,PD55,SUS420J2,SUS304,SUS316							
被切削材硬度 立銑R徑 mm	HRC30度以下				HRC30-45度				HRC45-50度			
	等高切削		曲面切削		等高切削		曲面切削		等高切削		曲面切削	
	轉速	進給	轉速	進給	轉速	進給	轉速	進給	轉速	進給	轉速	進給
	轉/分	mm/分	轉/分	mm/分	轉/分	mm/分	轉/分	mm/分	轉/分	mm/分	轉/分	mm/分
R0.5	45.000	880	31.000	620	35.700	570	25.000	400	19.000	210	13.300	150
R1.0	22.000	880	15.500	620	17.800	570	12.500	400	9.500	210	6.600	150
R1.5	15.000	900	10.600	630	12.100	570	8.500	400	6.400	210	4.500	150
R2.0	11.400	900	8.000	630	9.100	640	6.400	450	4.800	270	3.400	190
R2.5	9.100	900	6.400	630	7.100	640	5.000	450	3.800	290	2.700	200
R3.0	7.600	900	5.300	670	6.000	670	4.200	470	3.200	300	2.200	210
R4.0	5.700	1.140	4.000	800	4.600	790	3.200	550	2.300	320	1.600	220
R5.0	4.600	1.070	3.200	750	3.600	740	2.500	520	1.900	330	1.300	230
R6.0	3.900	1.000	2.700	700	3.000	700	2.100	490	1.600	310	1.100	220
R8.0	2.900	930	2.000	650	2.300	670	1.600	470	1.100	270	770	190
R10.0	2.300	810	1.600	570	1.900	640	1.300	450	950	250	660	180
R12.5	1.900	670	1.300	470	1.400	510	1.000	360	760	210	530	150

最大切削量

被切削材	鐵材、碳素鋼、鑄鐵、合金鋼、工具鋼				合金鋼、工具鋼、不鏽鋼、熱處理鋼				熱處理鋼			
	SS41,S45C,FC,FCD,SCr,SCM,SNC,SNM,SK,SKS,SKT,SKD,PDS1,PDS3,S50C,YK30				SCr,SCM,SNC,SNM,SKT,SKD,P20,P20S,NAK55,NAK80,FDAC,PD55,SUS420J2,SUS304,SUS316							
被切削材硬度 立銑R徑 mm	HRC30度以下				HRC30-45度				HRC45-50度			
	等高切削		曲面切削		等高切削		曲面切削		等高切削		曲面切削	
	轉速	進給	轉速	進給	轉速	進給	轉速	進給	轉速	進給	轉速	進給
	轉/分	mm/分	轉/分	mm/分	轉/分	mm/分	轉/分	mm/分	轉/分	mm/分	轉/分	mm/分
R0.5	50.000	2.200	35.000	1.500	50.000	2.000	35.000	1.400	32.000	1.100	22.400	800
R1.0	25.000	2.200	17.500	1.500	24.500	2.000	17.000	1.400	17.000	1.200	11.900	800
R1.5	16.500	2.200	11.600	1.500	16.000	2.000	11.200	1.400	11.500	1.200	8.000	800
R2.0	15.500	2.700	10.800	1.900	15.000	2.200	10.500	1.500	11.000	1.500	7.700	1.040
R2.5	15.000	3.200	10.500	2.200	14.000	2.300	9.800	1.600	10.000	1.680	7.000	1.170
R3.0	13.500	3.400	9.500	2.400	11.500	2.200	8.000	1.500	9.500	1.800	6.600	1.280
R4.0	10.000	2.500	7.000	1.960	9.000	1.700	6.300	1.200	7.100	1.360	5.000	960
R5.0	8.200	2.100	5.700	1.400	7.200	1.360	5.000	960	5.700	1.080	4.000	760
R6.0	6.800	1.700	4.700	1.200	6.000	1.100	4.200	800	4.800	880	3.300	610
R8.0	5.100	1.300	3.600	880	4.500	840	3.200	600	3.600	780	2.500	540
R10.0	4.100	1.000	2.900	720	3.600	680	2.500	480	2.900	540	2.000	380
R12.5	3.300	850	2.300	600	2.900	540	2.000	380	2.200	360	1.500	250

最大切削量

TOPTAP PRECISION TOOLS

TOPTAP PRECISION TOOLS